



VIBRATION ANALYSIS HARDWARE



**DSB1002 Series Modular Switch Box
32 Dual Output Sensor Inputs
Product Manual**

TABLE OF CONTENTS

- Introduction.....3
- Product Description.....3
- Product Dimensions and Diagram4
- Mounting Instructions.....5
- Conduit Entry6
- Grounding.....7
- Installation of Sensor/Signal Input Cable.....8
- Post Installation Testing 12
- Warranty and Return Information 14



INTRODUCTION

CTC modular switch box solutions allow for the monitoring of remotely-mounted vibration sensors, which would otherwise be restricted to human access due to safety considerations.

DSB1002 Series Modular Switch Box Overview: Four, eight, 12, and 16 position switched output for dual output vibration and temperature sensors or biaxial accelerometers, for a total of eight, 16, 24, or 32 channels of measurement data respective to the model purchased, fiberglass enclosure

The DSB1002 fiberglass modular switch box is used to convert the three-conductor wiring of up to 16 remotely installed dual output sensors to two switched BNC connectors and one switched three-pin MIL spec connector for portable data collection. BNC labeled "A" and the three-pin MIL provide output for vibration and the BNC labeled "B" provides output for temperature or vibration channel 2 measurements. Input wiring from each sensor is connected via quick-connect or screw terminal blocks. Each terminal block includes input for signal, temperature, negative and shield. The shield drain wire is earth-grounded via a ground stud that is mounted to the side of the fiberglass enclosure.

Additional switch box modules can be installed or removed after initial manufacturing and onsite installation, using the quick-release DIN rail clip. If continuous output is desired, select the DSB1003 Series. On all continuous output modules, a quick disconnect T-plug is available to easily connect and disconnect the input wiring.

Rated for NEMA 4X (IP66), the DSB1002/DSB1003 can withstand harsh environments including temperatures ranging from -58°F to 180°F (-50°C to 82°C). The box is also resistant to hose-directed fluid and corrosion. A snap latch is installed on the door allowing the box to be sealed from the elements when not in use.



PRODUCT DIMENSIONS

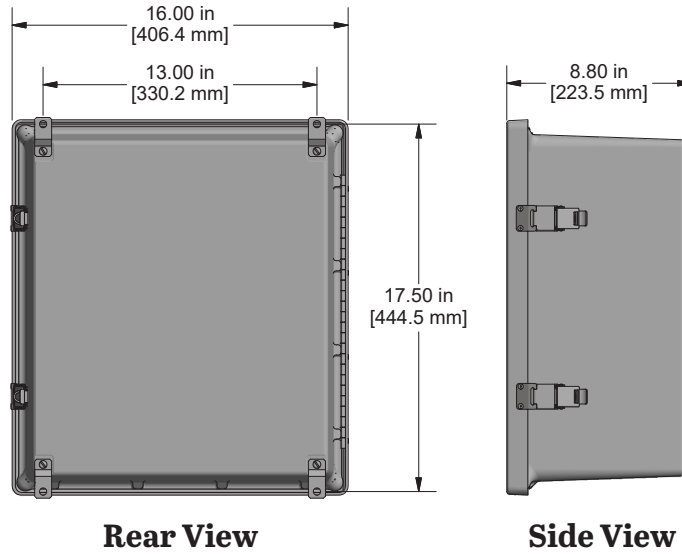

Figure 1. Dimensions

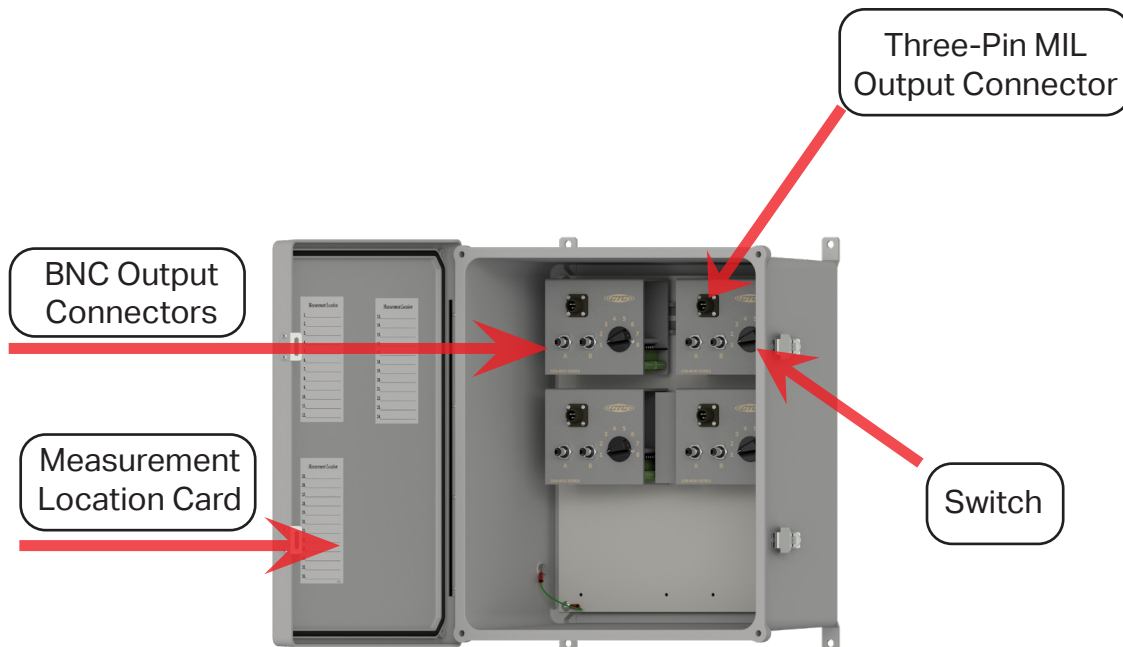

Figure 2. Diagram

MOUNTING INSTRUCTIONS

Note: If you have purchased a modular switch box without cable entries provided, you should add your own entry prior to mounting the modular switch box. CTC does not recommend putting holes in the top of the enclosure due to access and moisture concerns.

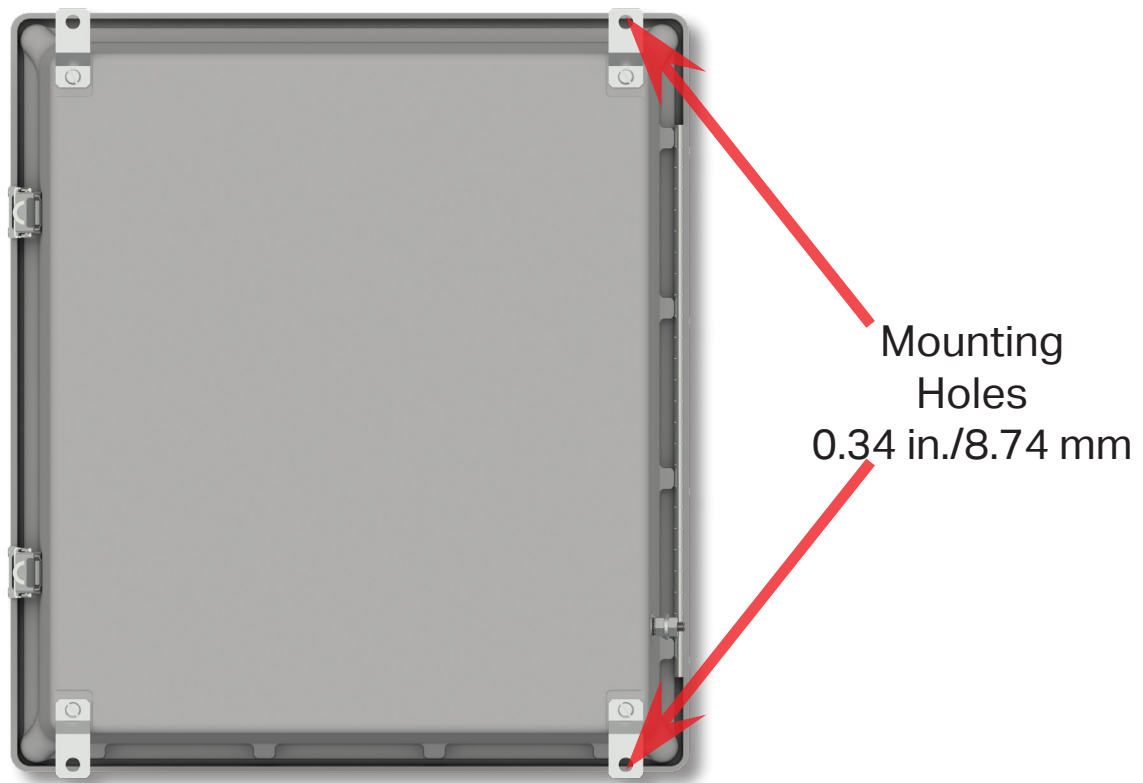

Figure 3. Modular Switch Box Rear View

CONDUIT ENTRY

If you are running conduit to your enclosure, ensure the conduit cable entry enters from the bottom of the enclosure when mounted.

Note: To ensure moisture will not flow into the enclosure, a hole should be drilled at the lowest point in the conduit to provide drainage for any moisture.

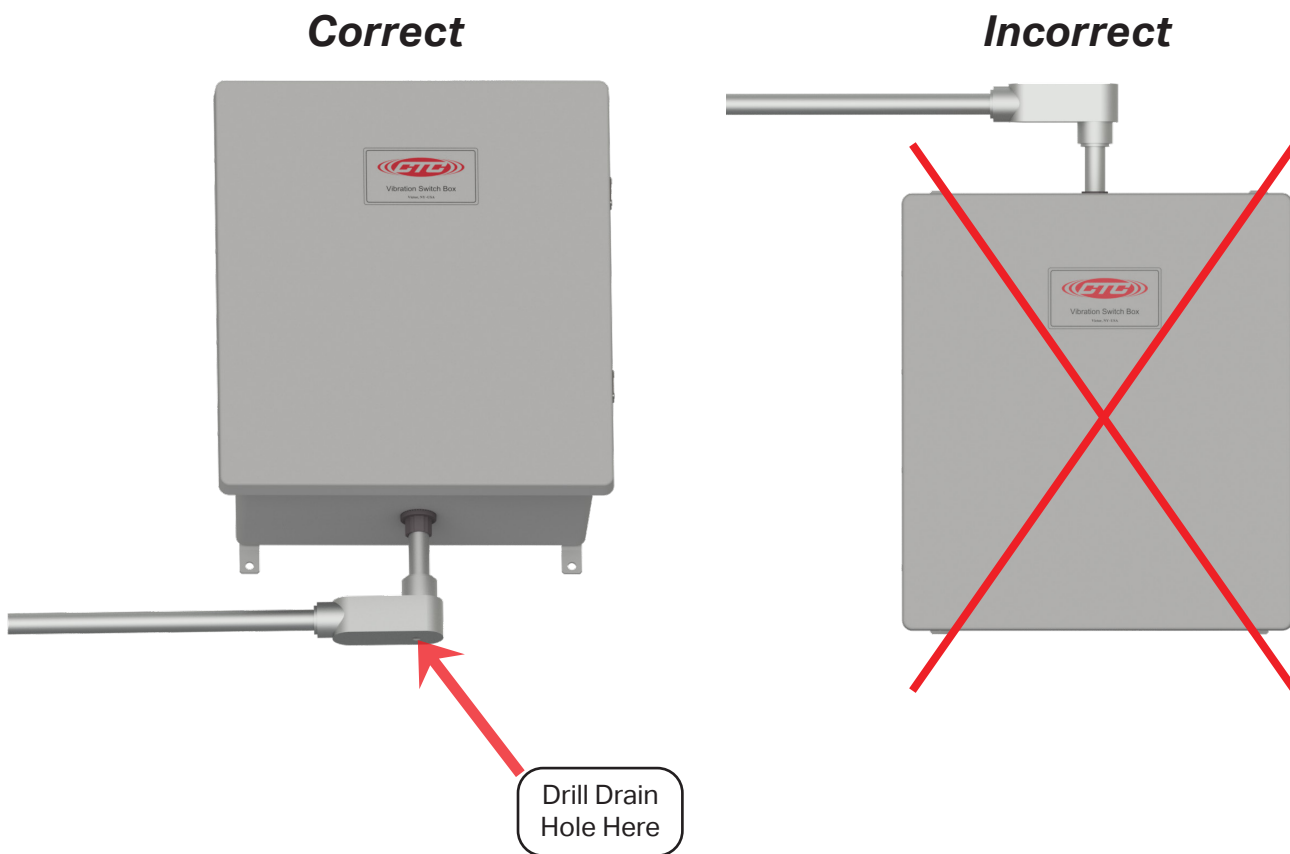

Figure 4. Conduit Entry for Modular Switch Box

GROUNDING

Ensure the shield ground wire on the DSB1002 Series modular switch box is grounded to earth ground.

A. Mounting to Earth Ground

When mounting DSB1002 Series modular switch boxes to earth ground (such as an I-Beam), mount the shield ground wire using a mounting bolt through one of the mounting brackets on the enclosure.



Figure 5. Proper Shield Grounding Technique

B. Mounting to Non-Grounded Structure

When mounting the modular switch box to a non-grounded structure, ensure the shield ground wire or customer supplied ground wire is tied to a source of earth ground.

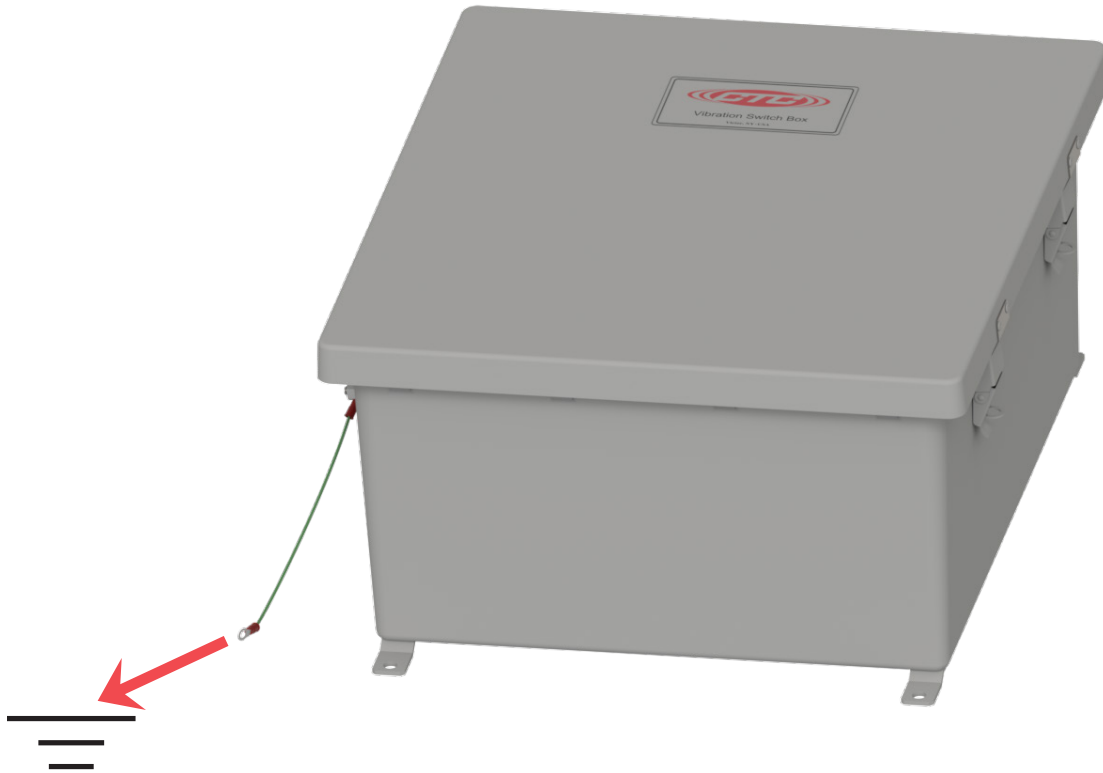

Figure 6. Ground Wire Placement

SENSOR INSTALLATION

Installation of Sensors/Signal Input Cable

1. Feed blunt-cut end through the cable entry at the bottom of the enclosure.
Note: It is recommended that cables are marked on both ends.

For cord grip cable entry, take off the cord grip cover with bushing and run cable into enclosure, hand tighten cord grip cover to base to prevent damage of cord grip.

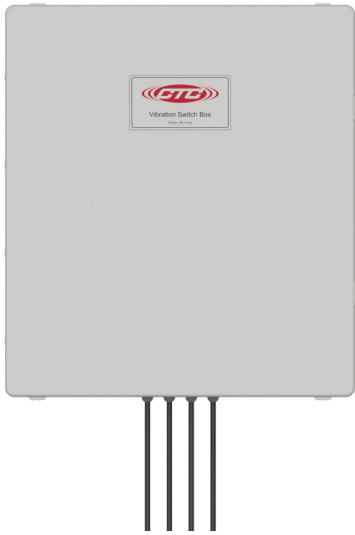

Figure 7. Front View



Figure 8. Bottom View

1. Strip outer jacket of cable back 1¼ in. - 1½ in. and remove all of the shielding.
2. Strip red and black insulation back ¼ in.
3. Remove each terminal plug from respective channel.

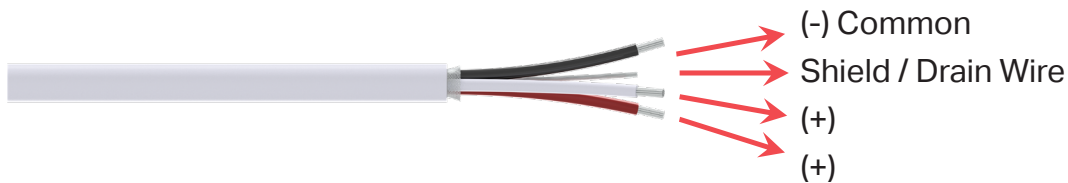
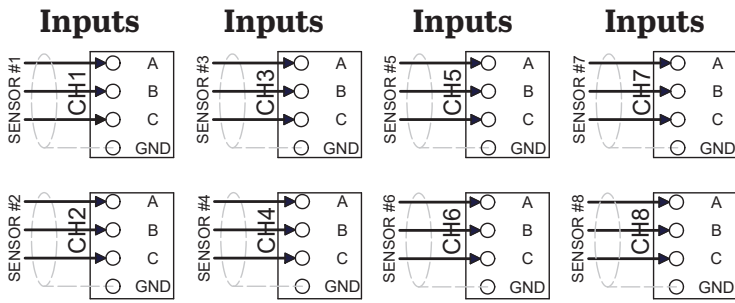

Figure 9. Stripped Wire

4. Locate the appropriate plug (identified by channel number), remove it, and install the wires using a small flathead screwdriver. Depress selected position button to open terminal for respective wire. Push plug back into location. Refer to the table on page 11 for the correct orientation, based on application.



See input wiring chart on the next page for the specific type of sensor you are utilizing.



Figure 10. Connecting Cables to Modular Switch Box (DSB1002)

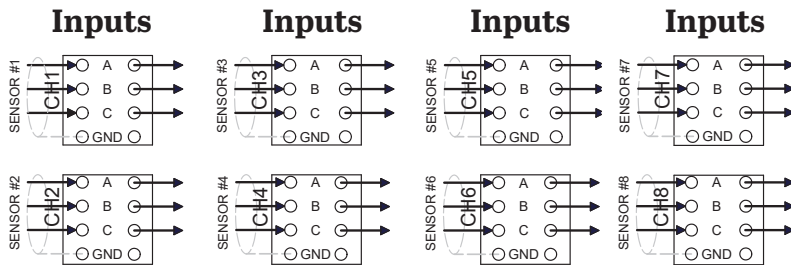

Figure 11. Connecting Cables to Modular Switch Box (DSB1003)

5. Insert plug into the appropriate PC board connector and double check to ensure that the cable is going to the correct channel.
6. Mark the Measurement Location Card located on the inside front cover with a description of each measurement location.

DUAL OUTPUT - VIBRATION & TEMPERATURE		
SOCKET A	RED WIRE	VIBRATION (+)
SOCKET B	BLACK WIRE	COMMON
SOCKET C	WHITE WIRE	TEMPERATURE (+)
SOCKET GND	SHIELD DRAIN	SHIELD

BIAXIAL VIBRATION - AXIS X & Z		
SOCKET A	GREEN WIRE	AXIS X (+)
SOCKET B	BLACK WIRE	COMMON
SOCKET C	WHITE WIRE	AXIS Z (+)
SOCKET GND	SHIELD DRAIN	SHIELD

Note: CTC recommends using 4 conductor cables such as CB105, CB119, CB192, CB218, CB618, CB818, or CB819 for biaxial applications. If using a 3 conductor cable such as CB112, CB191, CB212, CB512, CB612, or CB812 substitute the red wire for green.

TWO SINGLE AXIS VIBRATION ACCELEROMETERS		
SOCKET A	RED WIRE	SENSOR 1 (+)
SOCKET B	BLACK WIRE	COMMON
SOCKET C	RED WIRE	SENSOR 2 (+)
SOCKET GND	SHIELD DRAIN	SHIELD

Table 1. Wiring Instructions for Various Applications

POST INSTALLATION TESTING

The TM1018 Accelerometer Verification Meter can be used to verify cable conductivity, sensor location and proper wiring connections. The Verification Meter will indicate if the sensor, cable and/or junction box is in working condition. It will also confirm bias voltage of the accelerometer, which will inform you of the operation of the internal accelerometer amplifier.

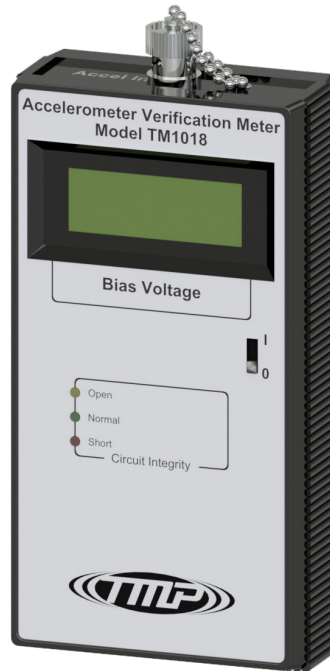

Figure 12. TM1018 Accelerometer Verification Meter

Testing Method:

1. Utilizing two personnel, Person A will be located at the modular switch box, while Person B will be located at the measurement location.
2. Once positioned, Person A will connect the TM1018 to the data collector output to the modular switch box and turn the Channel Selector to the channel that corresponds to the referenced measurement. Person A should observe a "NORMAL" LED reading.
3. Person B disconnects the cable from the accelerometer, and the TM1018 should respond with an "OPEN" LED. Reconnect the cable to the accelerometer, and the TM1018 should respond with a "NORMAL" LED.
4. Repeat for each measurement location to verify that accelerometer location is properly identified at the modular switch box.

The following LED Readout indicates the circuit integrity:

1. Green LED: Normal. Indicates proper connection and an output bias will be given, indicating the health of the sensor (4 – 16 V indicates a healthy accelerometer).
2. Yellow LED: Open Circuit. Indicates one of the following:
 - a. Cable connector is not connected to accelerometer.
 - b. Cable is open circuit (broken or not connected at one end).
 - c. Accelerometer is not functioning correctly.
3. Red LED: Short Circuit. Indicates one of the following:
 - a. Water or contamination in the connector.
 - b. Reverse wiring ((+) and (-) leads are reversed).
 - c. Wires in modular switch box or cable connector (+) & (-) are touching.



WARRANTY AND REFUND

Please visit www.ctconline.com to view a complete recapitulation of our warranty and refund policies.

CONTACT INFORMATION

Connection Technology Center, Inc. (CTC)

7939 Rae Blvd.

Victor, NY 14564

1.585.924.5900

sales@ctconline.com

www.ctconline.com

