



**VIBRATION ANALYSIS HARDWARE**



**MX333 Series MAXX Box  
16 Triaxial Sensor Inputs  
Product Manual**

## TABLE OF CONTENTS

- Introduction.....3
- Product Description.....3
- Product Dimensions & Diagram.....4
- Mounting Instructions.....5
- Conduit Entry .....6
- Grounding.....7
- Installation of Sensor / Signal Input Cable.....8
- Post-Installation Testing..... 11
- Warranty & Return Information ..... 12



## INTRODUCTION

CTC MAXX Box solutions allow for the monitoring of remotely mounted vibration sensors, which would otherwise be restricted to human access due to safety considerations.

### **MX333 Series MAXX Box Overview: *Sixteen triaxial sensor inputs (48 measurement channel outputs), fiberglass enclosure***

The MX333 is a fiberglass enclosure designed for data collection of up to 16 triaxial accelerometers. The MX333 provides connection of the four-conductor input wiring for a maximum of 16 triaxial accelerometers for portable data collection. Data is collected via four, four-pin output connectors compatible with Azima DLI Data Collector Cables. Input wiring from the sensors is wired to the outputs via terminal blocks located behind the hinged output panel. Inputs available on each terminal block include positive and negative for each axis or sensor signal, and one input for the shield drain wire that is grounded via an external ground stud mounted to the side of the fiberglass enclosure.

All MX333 enclosures feature a hinged cover with a mounted snap latch to protect each four-pin connector when not in use. Rated for NEMA 4X (IP66), the box is resistant to hose-directed fluid and corrosion and is rated for temperatures ranging from -58°F to 180°F (-50°C to 82°C).



# PRODUCT DIMENSIONS

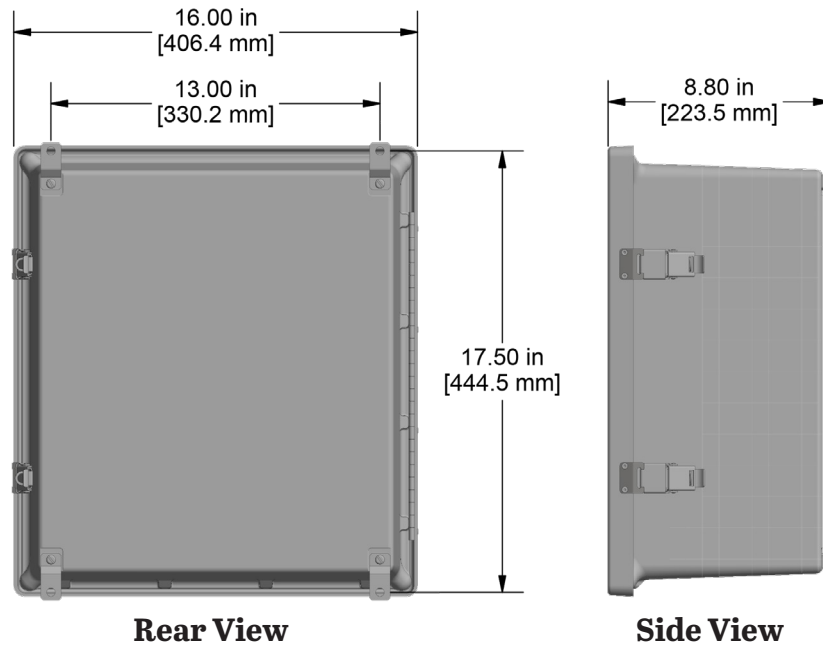

**Figure 1. Dimensions**

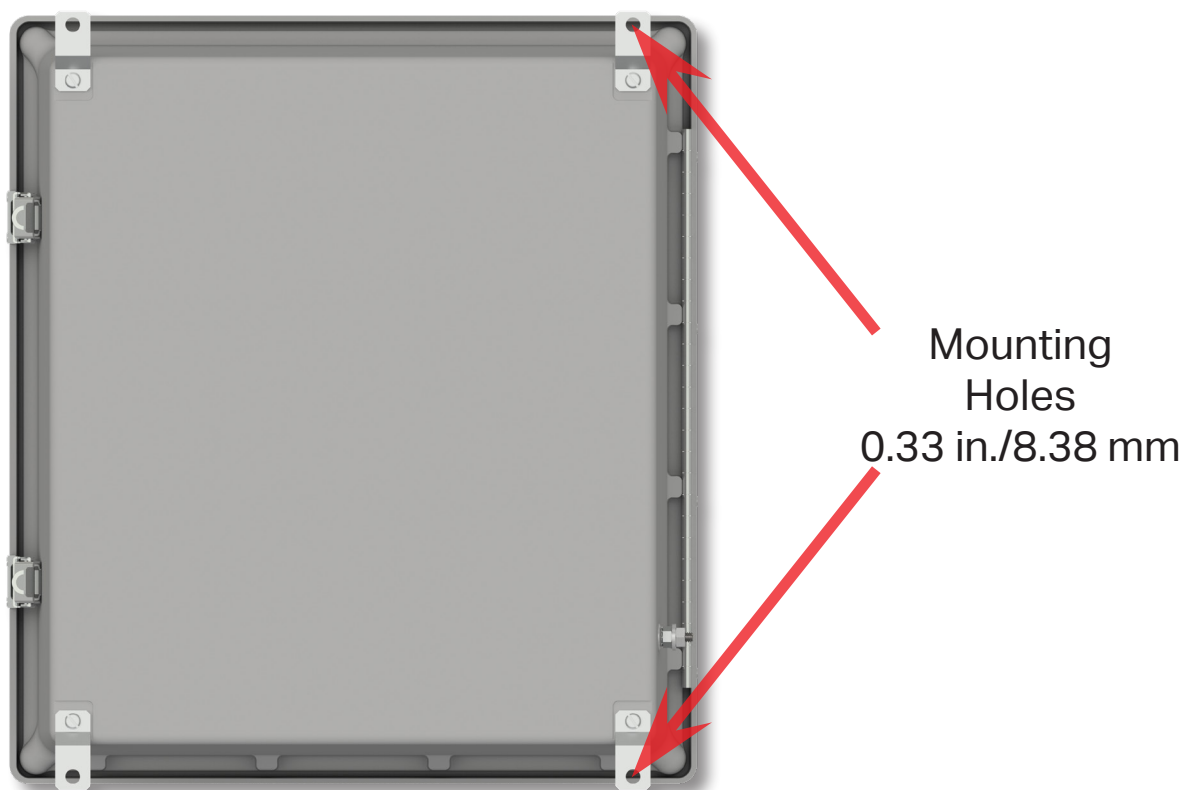

**Figure 2. Diagram**



## MOUNTING INSTRUCTIONS

**Note:** if you have purchased a MAXX Box without cable entries provided, you should add your own entry prior to mounting the enclosure. CTC does not recommend drilling holes in the top of the enclosure due to access and moisture concerns.

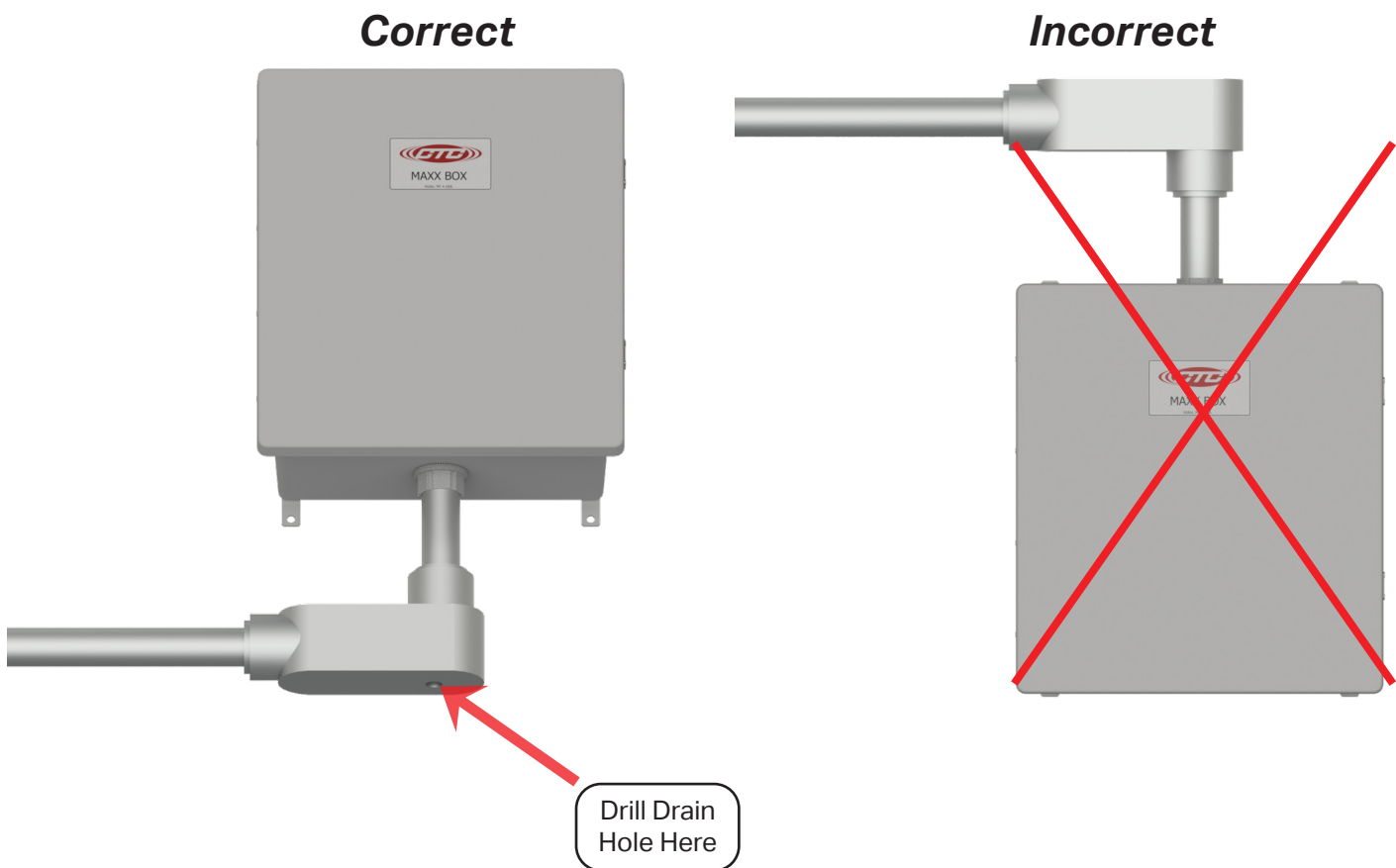

*Figure 3. MAXX Box Rear View*

## CONDUIT ENTRY

If you are running conduit to your enclosure, ensure the conduit cable entry is located at the bottom of the enclosure when mounted.

**Note:** To ensure moisture will not flow into the enclosure, a hole should be drilled at the lowest point in the conduit to provide drainage for any moisture.



**Figure 4. Conduit Entry for MAXX Box**

## GROUNDING

Ensure the shield ground wire on the MX333 Series MAXX Boxes is grounded to earth ground.

### *A. Mounting to Earth Ground*

When mounting MX333 Series MAXX Boxes to earth ground (such as an I-Beam), mount the shield ground wire using a mounting bolt through one of the mounting brackets on the enclosure.



**Figure 5. Proper Shield Grounding Technique**

## B. Mounting to Non-Grounded Structure

When mounting the termination box to a non-grounded structure, ensure the shield ground wire or customer-supplied ground wire is tied to a source of earth ground.

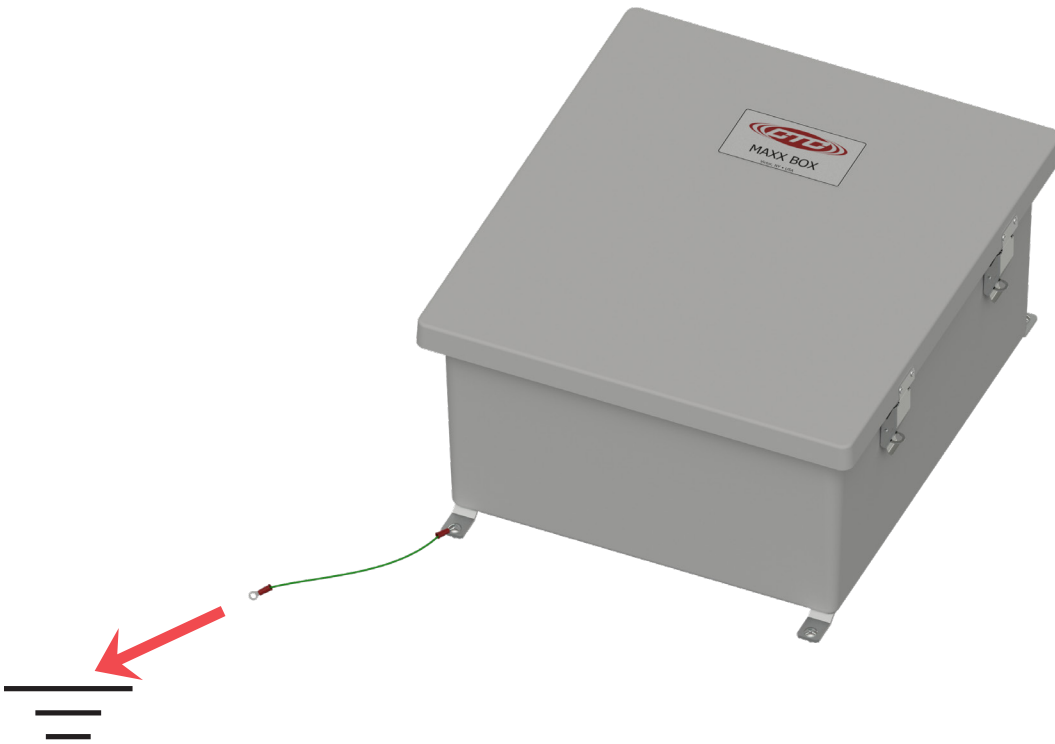

**Figure 6. Ground Wire Placement**

## SENSOR WIRING INSTALLATION

### Installation of Sensors/Signal Input Cable

1. Feed blunt-cut end through the cable entry at the bottom of the enclosure.  
**Note:** it is recommended that cables are marked on both ends.

For cord grip cable entry, take off the cord grip cover with bushing and run cable into enclosure, hand-tighten cord grip cover to base to prevent damage of cord grip.



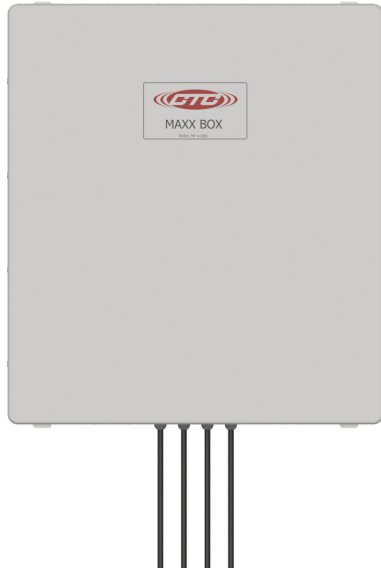
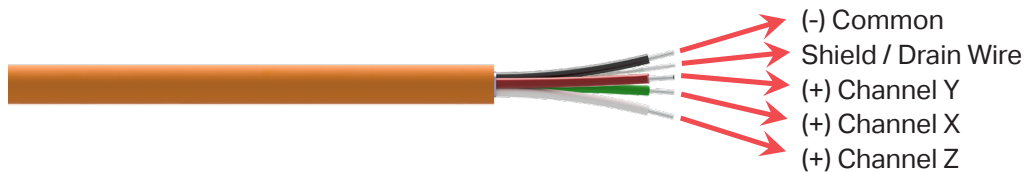

**Figure 7. Front View**



**Figure 8. Bottom View**

1. Strip outer jacket of cable back 1¼ in. and remove all of the shielding.
2. Separate the internal wires from the shield and twist the shield.
3. Strip red and black insulation back ¼ in.



**Figure 9. Stripped Wire**

4. Locate the appropriate plug, identified by channel number, remove the plug and install the wires using a small flathead screwdriver. Push plug back into location. Orientation is as follows:
  - a. White insulated conductor wire (Z) is connected to the first channel used.
  - b. Red insulated conductor wire (Y) is connected to the second channel used.
  - c. Green insulated conductor wire (X) is connected to the third channel used.
  - d. Black insulated conductor wire is connected to (-) common.
  - e. Shield drain wire is connected to ground (GND).

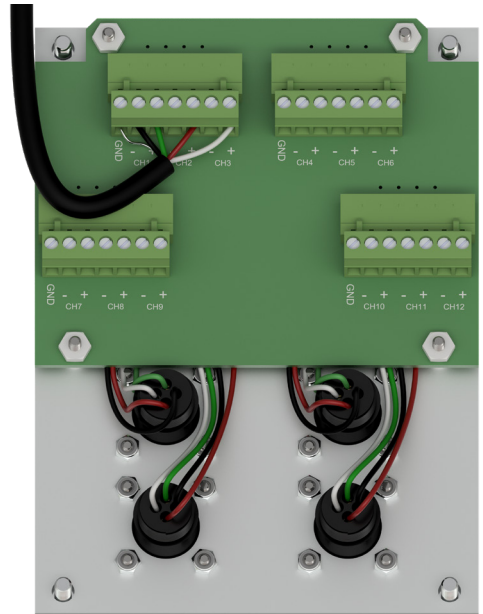
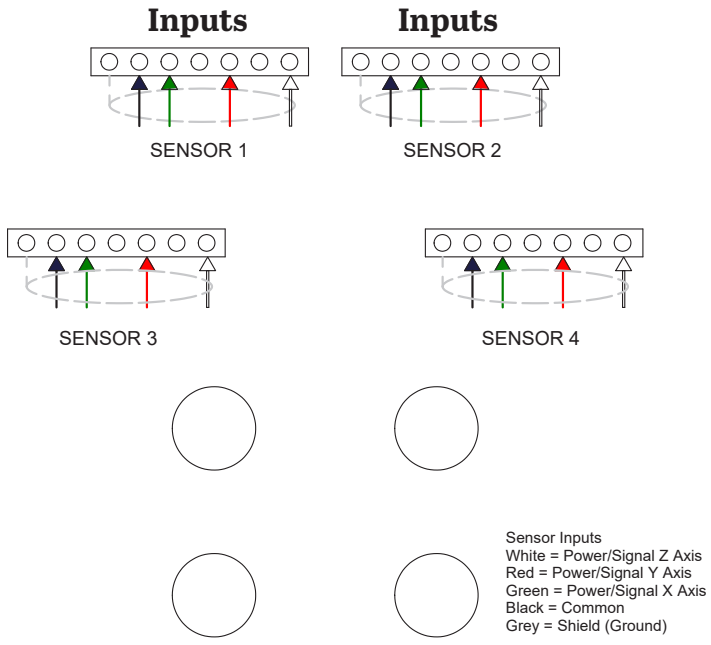
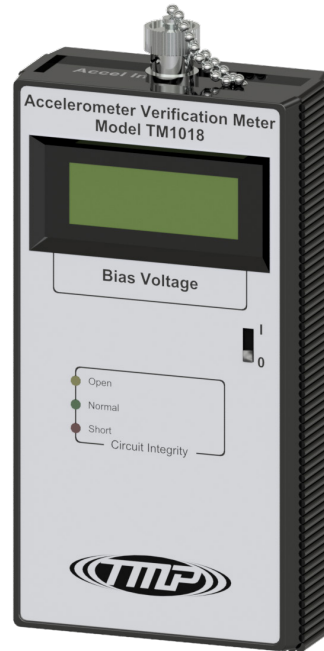

**Figure 10. Field Wiring for Four-Conductor Triaxial Sensor Inputs**

5. Mark the Measurement Location Card located on the inside front cover with a description of each measurement location.

## POST-INSTALLATION TESTING

The TM1018 Accelerometer Verification Meter can be used to verify cable conductivity, sensor location and proper wiring connections. The Verification Meter will indicate if the sensor, cable and/or junction box is in working condition. It will also confirm bias voltage of the accelerometer, which will inform you of the operation of the internal accelerometer amplifier.



**Figure 11. TM1018 Accelerometer Verification Meter**

### Testing Method:

1. Utilizing two personnel, Person A will be located at the MAXX Box, while Person B will be located at the measurement location.
2. Once positioned, Person A will connect the TM1018 to the data collector output on the termination box and turn the Channel Selector to the channel that corresponds to the referenced measurement. Person A should observe a "NORMAL" LED reading.
3. Person B disconnects the cable from the accelerometer, and the TM1018 should respond with an "OPEN" LED. Reconnect the cable to the accelerometer, and the TM1018 should respond with a "NORMAL" LED.
4. Repeat for each measurement location to verify that accelerometer location is properly identified at the termination box.

The following LED Readout indicates the circuit integrity:

1. Green LED: Normal. Indicates proper connection and an output bias will be given, indicating the health of the sensor (4 – 16 V indicates a healthy accelerometer).
2. Yellow LED: Open Circuit. Indicates one of the following:
  - a. Cable connector is not connected to accelerometer.
  - b. Cable is open circuit (broken or not connected at one end).
  - c. Accelerometer is not functioning correctly.
3. Red LED: Short Circuit. Indicates one of the following:
  - a. Water or contamination in the connector.
  - b. Reverse wiring ((+) and (-) leads are reversed).
  - c. Wires in termination box or cable connector (+) & (-) are touching.

## **WARRANTY & REFUND**

Please visit [www.ctconline.com](http://www.ctconline.com) to view a complete recapitulation of our warranty and refund policies.

## **CONTACT INFORMATION**

Connection Technology Center, Inc. (CTC)

7939 Rae Blvd.

Victor, NY 14564

1.585.924.5900

[sales@ctconline.com](mailto:sales@ctconline.com)

[www.ctconline.com](http://www.ctconline.com)

