



VIBRATION ANALYSIS HARDWARE



**MX433 Series MAXX Box
4 Triaxial Sensor Inputs
Product Manual**

TABLE OF CONTENTS

- Introduction.....3
- Product Description.....3
- Product Dimensions & Diagram.....4
- Mounting Instructions.....5
- Conduit Entry6
- Grounding.....7
- Installation of Sensor/Signal Input Cable.....8
- Post-Installation Testing..... 11
- Warranty & Return Information 12



INTRODUCTION

CTC MAXX Box solutions allow for the monitoring of remotely mounted vibration sensors, which would otherwise be restricted to human access due to safety considerations.

MX433 Series MAXX Box Overview: *Four triaxial sensor inputs (12 measurement channel outputs), stainless steel enclosure*

The MX433 is a stainless steel enclosure designed for data collection of up to four triaxial accelerometers. The MX433 provides connection of the four-conductor input wiring for a maximum of four triaxial accelerometers for portable data collection. Data is collected via four, four-pin output connectors compatible with Azima DLI Data Collector Cables. Input wiring from the sensors is wired to the outputs via terminal blocks located behind the hinged output panel. Inputs available on each terminal block include signal/power and common for each axis or sensor signal, and one input for the shield drain wire that is grounded via an external ground stud mounted to the side of the fiberglass enclosure.

All MX433 enclosures feature a hinged cover with a mounted snap latch to protect each four-pin connector when not in use. Rated for NEMA 4X (IP66), the box is resistant to hose-directed fluid and corrosion and is rated for temperatures ranging from -58°F to 180°F (-50°C to 82°C).



PRODUCT DIMENSIONS

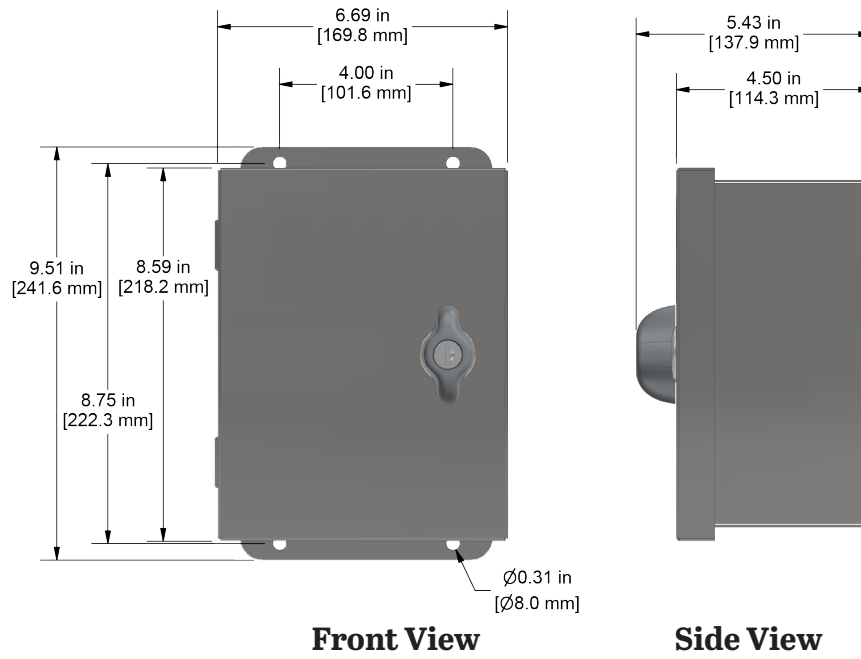

Figure 1. Dimensions

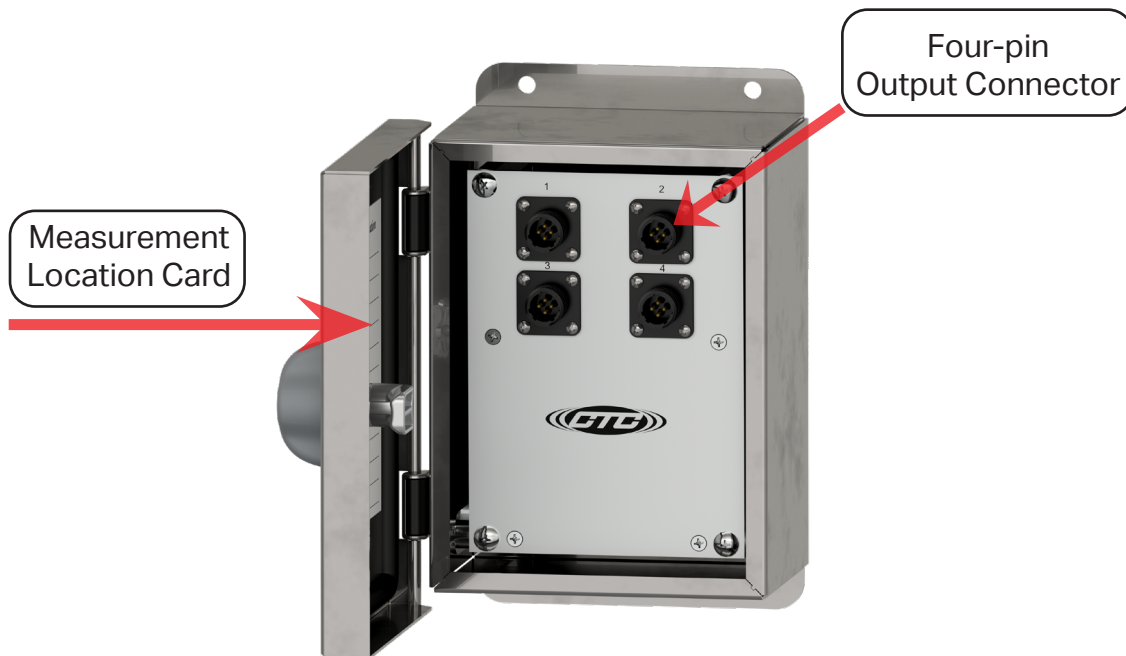

Figure 2. Diagram

MOUNTING INSTRUCTIONS

Note: if you have purchased a MAXX Box without cable entries provided, you should add your own entry prior to mounting the enclosure. CTC does not recommend drilling holes in the top of the enclosure due to access and moisture concerns.

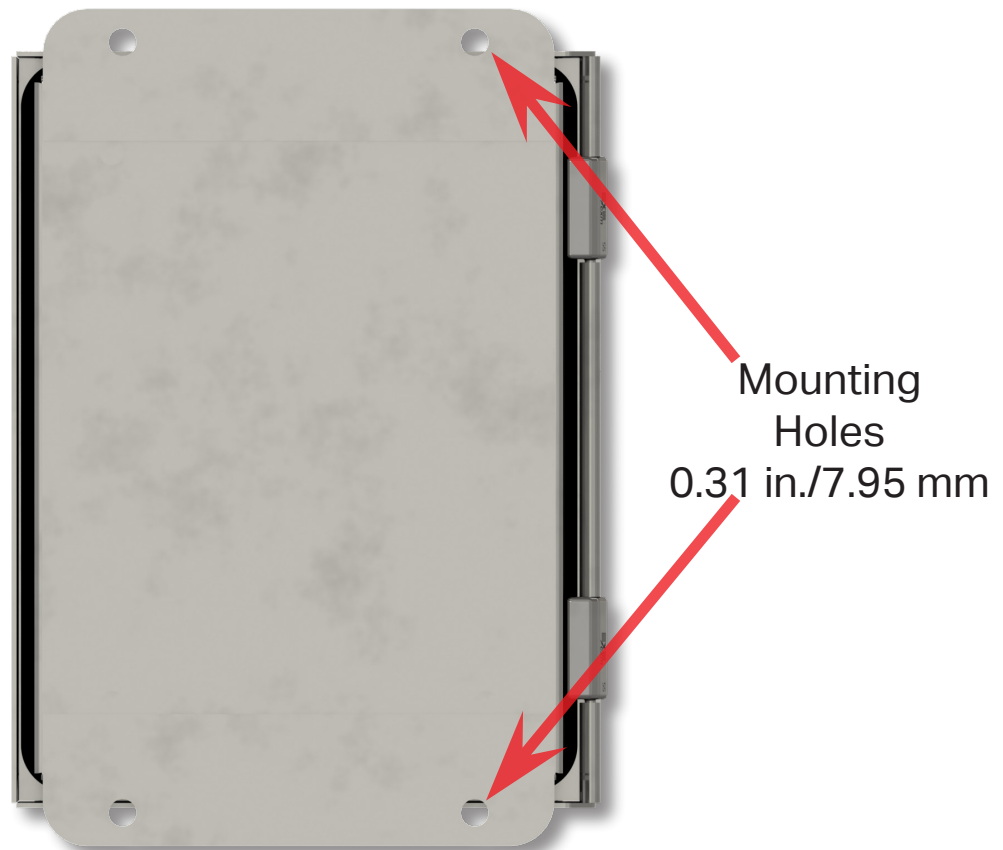

Figure 3. MAXX Box Rear View

CONDUIT ENTRY

If you are running conduit to your enclosure, ensure the conduit cable entry is located at the bottom of the enclosure when mounted.

Note: To ensure moisture will not flow into the enclosure, a hole should be drilled at the lowest point in the conduit to provide drainage for any moisture.

Correct

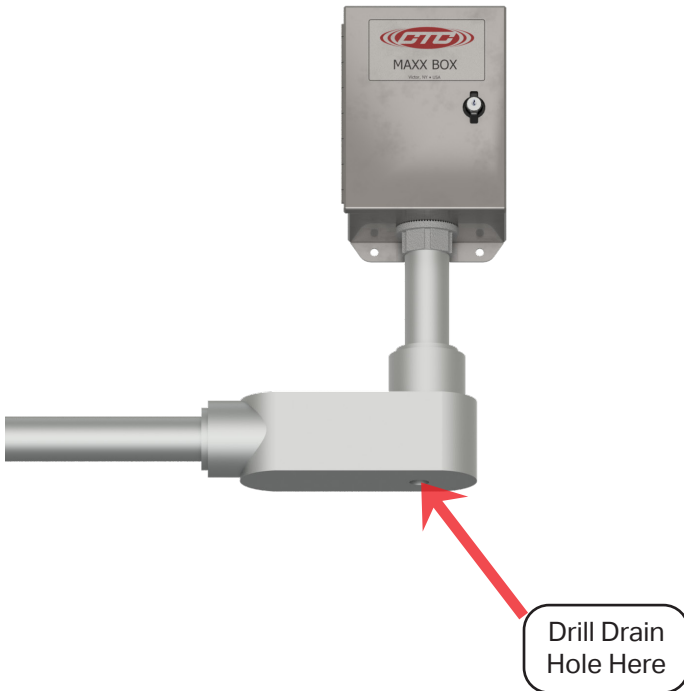

Incorrect



Figure 4. Conduit Entry for Switch Box

GROUNDING

Ensure the shield ground wire on the MX433 Series MAXX Box is grounded to earth ground.

A. Mounting to Earth Ground

When mounting MX433 Series MAXX Boxes to earth ground (such as an I-Beam), no additional steps are necessary, as the enclosure is grounded internally.



Figure 5. Switch Box (MX433) Earth Ground

B. Mounting to Non-Grounded Structure

When mounting the MAXX Box to a non-grounded structure, ensure the shield ground wire or customer-supplied ground wire is tied to a source of earth ground.

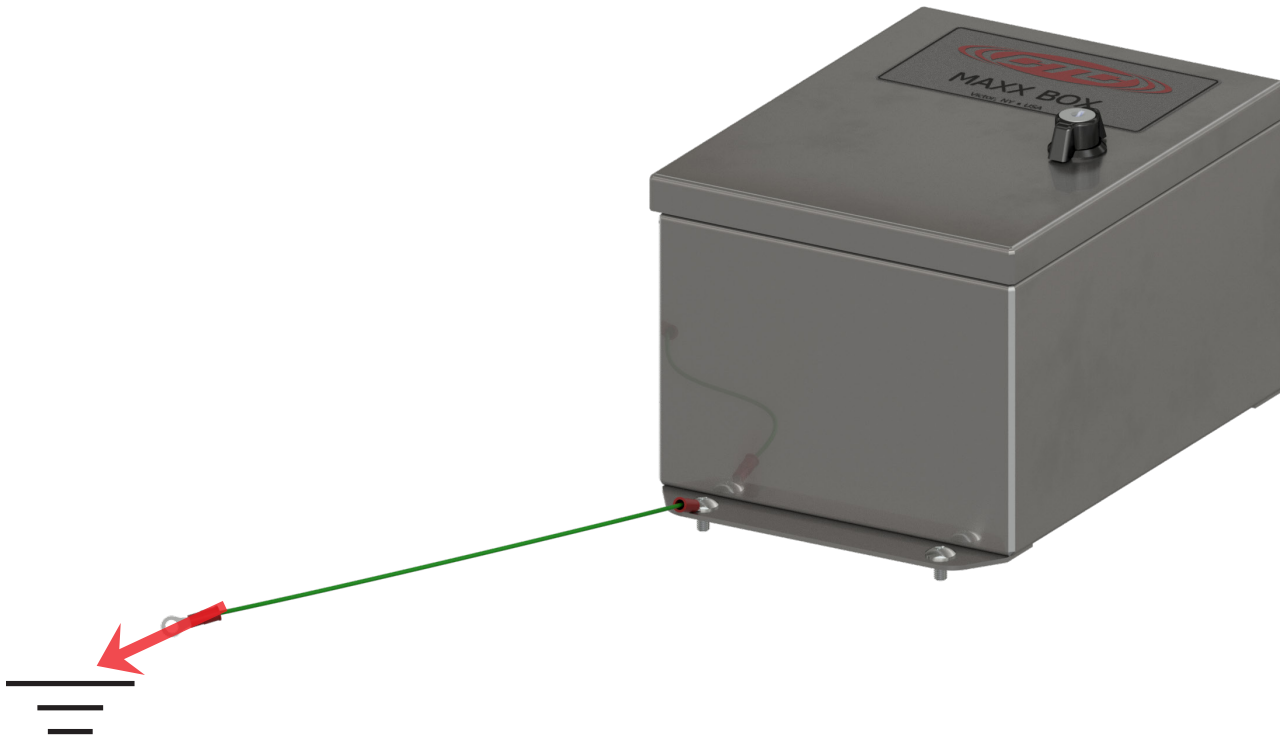

Figure 6. Ground Wire Placement

SENSOR INSTALLATION

Installation of Sensors/Signal Input Cable

1. Feed blunt-cut end through the cable entry at the bottom of the enclosure.
Note: it is recommended that cables are marked on both ends.

For cord grip cable entry, take off the cord grip cover with bushing and run cable into enclosure, hand tighten cord grip cover to base to prevent damage of cord grip.



Figure 7. Front View



Figure 8. Bottom View

1. Strip outer jacket of cable back 1¼ in. and remove all of the shielding.
2. Separate the internal wires from the shield and twist the shield.
3. Strip red, black, green and white insulation back ¼ in.

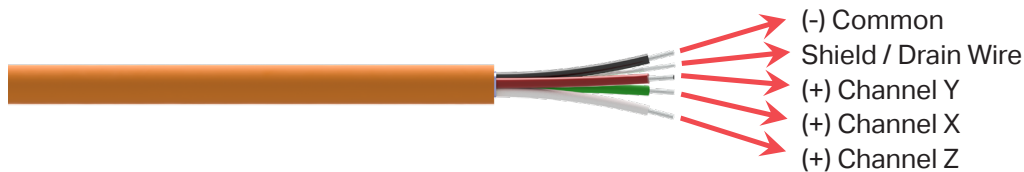

Figure 9. Stripped Wire

4. Locate the appropriate plug, identified by channel number, remove the plug and install the wires using a small flathead screwdriver. Push plug back into location. Orientation is as follows:
 - a. White insulated conductor wire (Z) is connected to the first channel used.
 - b. Red insulated conductor wire (Y) is connected to the second channel used.
 - c. Green insulated conductor wire (X) is connected to the third channel used.
 - d. Black insulated conductor wire is connected to (-) common.
 - e. Shield drain wire is connected to ground (GND).

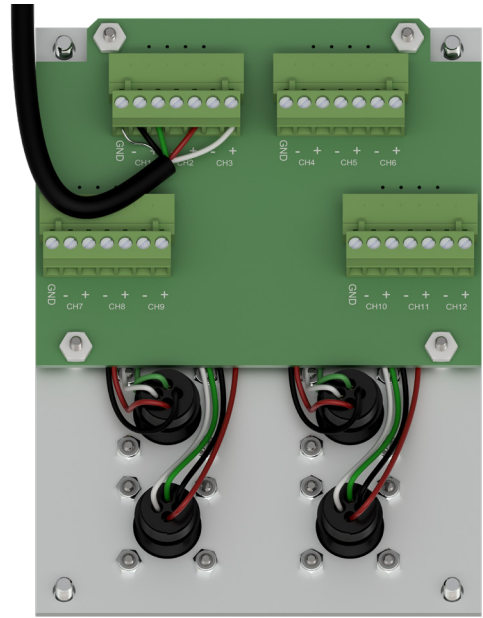
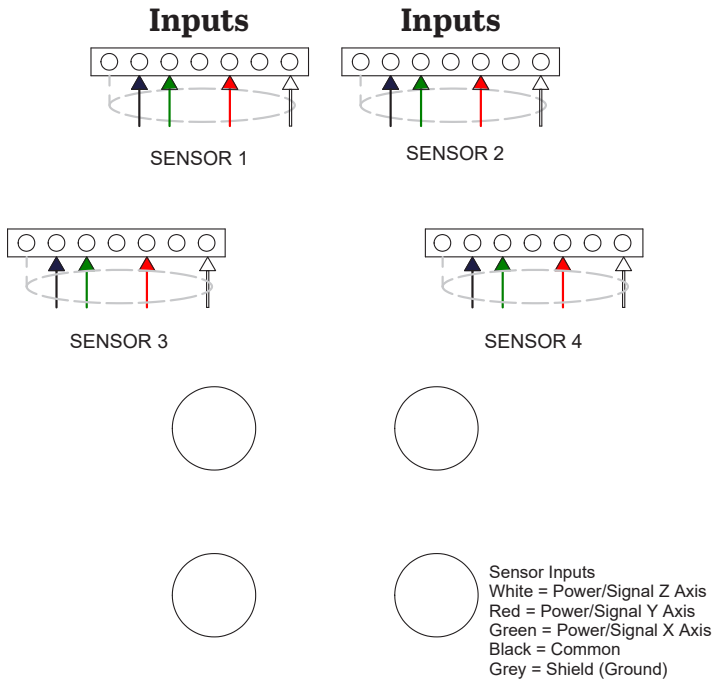

Figure 10. Field Wiring for Four-Conductor Triaxial Sensor Inputs

5. Mark the Measurement Location Card located on the inside front cover with a description of each measurement location.

POST-INSTALLATION TESTING

The TM1018 Accelerometer Verification Meter can be used to verify cable conductivity, sensor location and proper wiring connections. The Verification Meter will indicate if the sensor, cable and/or junction box is in working condition. It will also confirm bias voltage of the accelerometer, which will inform you of the operation of the internal accelerometer amplifier.

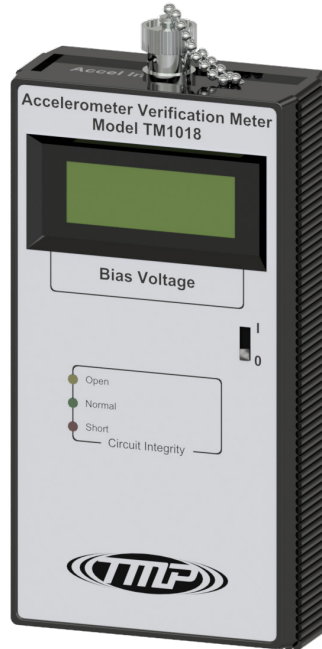

Figure 11. TM1018 Accelerometer Verification Meter

Testing Method:

1. Utilizing two personnel, Person A will be located at the MAXX Box, while Person B will be located at the measurement location.
2. Once positioned, Person A will connect the TM1018 to the data collector output on the termination box and turn the Channel Selector to the channel that corresponds to the referenced measurement. Person A should observe a "NORMAL" LED reading.
3. Person B disconnects the cable from the accelerometer, and the TM1018 should respond with an "OPEN" LED. Reconnect the cable to the accelerometer, and the TM1018 should respond with a "NORMAL" LED.
4. Repeat for each measurement location to verify that accelerometer location is properly identified at the termination box.

The following LED Readout indicates the circuit integrity:

1. Green LED: Normal. Indicates proper connection and an output bias will be given, indicating the health of the sensor (4 – 16 V indicates a healthy accelerometer).
2. Yellow LED: Open Circuit. Indicates one of the following:
 - a. Cable connector is not connected to accelerometer.
 - b. Cable is open circuit (broken or not connected at one end).
 - c. Accelerometer is not functioning correctly.
3. Red LED: Short Circuit. Indicates one of the following:
 - a. Water or contamination in the connector.
 - b. Reverse wiring ((+) and (-) leads are reversed).
 - c. Wires in termination box or cable connector (+) & (-) are touching.

WARRANTY & REFUND

Please visit www.ctconline.com to view a complete recapitulation of our warranty and refund policies.

CONTACT INFORMATION

Connection Technology Center, Inc. (CTC)

7939 Rae Blvd.

Victor, NY 14564

1.585.924.5900

sales@ctconline.com

www.ctconline.com

