



PROTECTION & RELIABILITY  
OPTIMIZATION INSTRUMENTS

A CTC COMPANY

# P R O D U C T M A N U A L

DX3307 / DP1007 / DD1007 / DC1007 Series



11mm Proximity Probe Assembly

# CONTENTS

---

<b>Section 1 : Overview</b> .....	<b>4</b>
Introduction .....	4
Description .....	4
<b>Section 2: Probe Details</b> .....	<b>5</b>
Proximity Probe Specifications .....	5
<b>Section 3: Cable Details</b> .....	<b>7</b>
Extension Cable Specifications.....	7
<b>Section 4: Driver Details</b> .....	<b>8</b>
Proximity Driver Specifications .....	8
<b>Section 5: Installation</b> .....	<b>10</b>
Installation Information .....	10
Electrical Connections .....	12
Target Surfaces.....	14
Setup and Adjustment .....	14
<b>Section 6: Operation</b> .....	<b>15</b>
Operation .....	15
<b>Section 7: Troubleshooting</b> .....	<b>16</b>
Troubleshooting Chart .....	16
<b>Section 8: Maintenance</b> .....	<b>17</b>
Maintenance .....	17
General.....	17
Warranty .....	17

# FIGURES

---

Figure 1 - 11mm Standard Mount Proximity Probe.....	6
Figure 2 - 11mm Reverse Mount Proximity Probe .....	6
Figure 3 - 11mm Proximity Probe Extension Cable.....	7
Figure 5 - 11mm Proximity Probe Driver .....	9
Figure 6 - Probe Tip Clearance .....	10
Figure 7 - Aluminum Clamping Mounting Block .....	11
Figure 8 - SST Mounting Bushings.....	11
Figure 9 - 4 Wire Connection .....	12
Figure 10 - 3 Wire Connection .....	13

# SECTION 1: OVERVIEW

---

## Introduction

This document contains information on the operation, installation and maintenance of the DX3307 / DP1007 / DC1007 / DD100780 proximity probe series products.

## Description

The DX3307 / DP1007 / DC1007 / DD100780 series proximity probe products utilize an eddy current that produces a negative voltage that is directly proportional to the “gap” distance between the probe and measured surface. The assembly consists of a proximity probe, extension cable and driver. The driver is a 3 or 4 wire device with connections for power, common, and signal output. The driver is intended for use with a DC negative voltage power supply.

# SECTION 2: PROBE DETAILS

---

## Proximity Probe Specifications

PRO Model: DP1007 Series  
Bently™ Compatible Model: DX3307 Series

### Environmental

Temperature Range: -31°F(-35°C) to 350°F(177°C)  
Humidity Range: 0-95% Relative, Non-condensing

### Electrical

Note: All specifications acquired through use of an AISI 4140 Steel target, 1.2" in Diameter.

#### Linear Range

Calibrated Linear Range: 20 to 180 mils (0.25 mm to 4.57 mm)  
Nominal Output: -1 to -17 VDC  
Nominal Sensitivity: 100 mV/mil (3.94 V/mm)

#### Incremental Scale Factor (ISF)

Note: When measured over calibrated linear range in increments of 10 mils

32°F(0°C) to 113°F(45°C)  
5 Meter System 100 mV/mil (3.94 V/mm) ± 10%  
9 Meter System 100 mV/mil (3.94 V/mm) ± 10%

-31°F(-35°C) to 248°F(120°C)  
5 Meter System 100 mV/mil (3.94 V/mm) ± 25%  
9 Meter System 100 mV/mil (3.94 V/mm) ± 25%

#### Deviation from best fit Straight Line (DSL)

Note: When measured over calibrated linear range in increments of 10 mils

32°F(0°C) to 113°F(45°C)  
5 Meter System ± 4.0 mil  
9 Meter System ± 4.0 mil

-31°F(-35°C) to 248°F(120°C)  
5 Meter System ± 20 mil  
9 Meter System ± 20 mil

### Physical

#### Materials:

8mm Tip: 40% Glass Filled PPS (Polyphenylene Sulfide)  
Threaded Case: Stainless Steel  
Coaxial Cable: FEP (Fluorinated Ethylene Propylene)  
Connector Material: 12-32 Threaded Gold Plated Brass with Teflon Insulators

#### Weight:

Probe: 1.5 kg (3.3 lb) Max

# SECTION 2: PROBE DETAILS

**Dimensions:**

- Cable Lengths: 1.0, 5.0, 9.0 Meters  
All probes have length tolerance of (-0% / +30%)
- ½-20 Standard Case: Available from 1.5" to 9.5" total length  
No thread lengths available in 0.5" increments up to 1" less than total case length  
7/16" wrench flats at rear of probe  
2x ¾" hex nuts for mounting
- M14x15 Standard Case: Available from 30mm to 250mm total length  
No thread lengths available in 10mm Increments up to 30mm less than total case length  
12mm wrench flats at rear of probe  
2x 22mm hex nuts for mounting
- 3/8-24 Reverse Mount: Available in 1.8" total length  
Integrated 7/16" wrench flats at front of probe body
- M10x1 Reverse Mount: Available in 45.7mm total length  
Integrated 12mm wrench flats at front of probe body

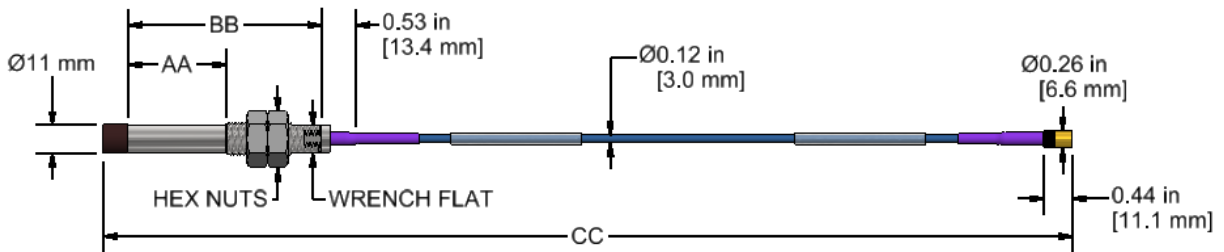

Figure 1 - 11mm Standard Mount Proximity Probe

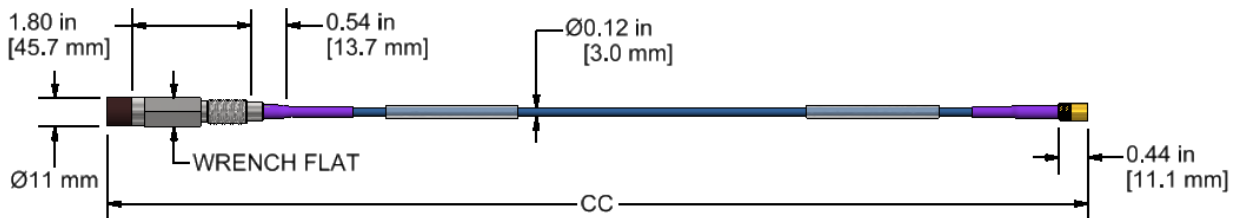

Figure 2 - 11mm Reverse Mount Proximity Probe

# SECTION 3: CABLE DETAILS

## Proximity Extension Cable Specifications

PRO Model: DC100730 Series  
Bently™ Compatible Model: DX330730 Series

### Environmental

Temperature Range: -31°F(-35°C) to 350°F(177°C)  
Humidity Range: 0-95% Relative, Non-condensing

### Physical

#### Materials:

Coaxial Cable: FEP (Fluorinated Ethylene Propylene)  
Connector Material: 12-32 Threaded Gold plated Brass with Teflon Insulators

#### Weight:

Cable: 1 kg (2.2 lb) Max

#### Dimensions:

Cable Lengths: 4.0, 8.0, Meters Nominal  
All cables have length tolerance of (-0% / +30%)

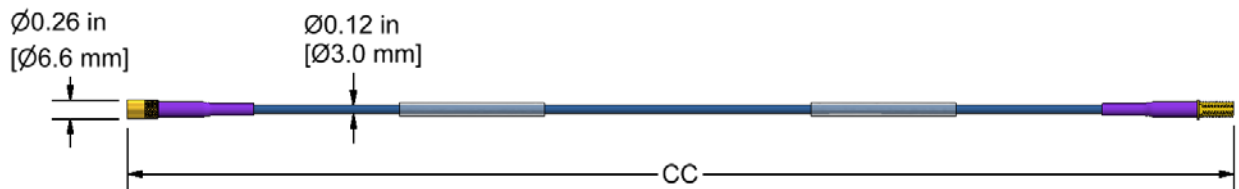

Figure 3 - 11mm Proximity Probe Extension Cable

# SECTION 4: DRIVER DETAILS

---

## Proximity Driver Specifications

PRO Model: DD1007 Series  
Bently™ Compatible Model: DX3307 Series

### Environmental

Temperature Range: -31°F(-35°C) to 185°F(85°C)  
Humidity Range: 0-95% Relative, Non-condensing

### Electrical

Note: All specifications acquired through use of a AISI 4140 Steel target, 1.2" in Diameter.

#### Linear Range

Calibrated Linear Range: 20 to 180 mils (0.5 mm to 4.57 mm)  
Nominal Output: -1 to -17 VDC  
Nominal Sensitivity: 100 mV/mil (3.94 V/mm)

#### Incremental Scale Factor (ISF)

Note: When measured over calibrated linear range in increments of 10 mils

32°F(0°C) to 113°F(45°C)  
5 Meter System 100 mV/mil (3.94 V/mm) ± 10%  
9 Meter System 100 mV/mil (3.94 V/mm) ± 10%

-31°F(-35°C) to 185°F(85°C)  
5 Meter System 100 mV/mil (3.94 V/mm) ± 25%  
9 Meter System 100 mV/mil (3.94 V/mm) ± 25%

#### Deviation from best fit Straight Line (DSL)

Note: When measured over calibrated linear range in increments of 10 mils

32°F(0°C) to 113°F(45°C)  
5 Meter System ± 4.0 mil  
9 Meter System ± 4.0 mil

-31°F(-35°C) to 185°F(85°C)  
5 Meter System ± 20 mil  
9 Meter System ± 20 mil

#### Operating Power:

Input Voltage Range: -17.5 to -30 VDC  
Power Consumption: 0.81W Max

Note: The Driver is protected against reversed polarity.

#### Isolation:

Case Isolation: Isolated from all connections



# SECTION 4: DRIVER DETAILS

## Physical

### Materials:

Case:	Aluminum
Panel/Din Mount Hardware	Aluminum
Prox Connector:	12-32 Threaded Gold Plated Brass with Teflon Insulators
BNC Connector:	Polyester Housing, Gold plated center contact, Polymethylpentene dielectric, Zinc or Nickel plated shell
Terminal Block:	Polyamide

### Weight:

Driver: 0.24 kg (0.53 lb) Max

### Mounting:

DinRail: 35mm Standard DinRail  
Panel: 2.0" x 2.0" Panel mount hole pattern  
**Note: Mounting Screws not included**

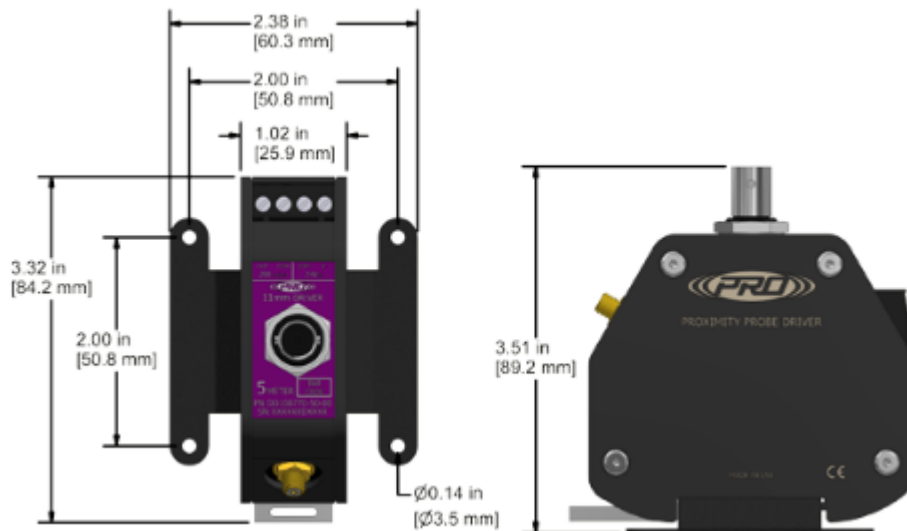

Figure 4 - 11mm Proximity Probe Driver

# SECTION 5 : INSTALLATION

## Installation Information

For most applications, it is recommended that the driver be mounted in a protective housing. More than one driver may share a single housing/enclosure to simplify installation. See PXE Series Enclosures. The drivers are typically din rail mounted in the enclosure. Connection to the probe is established when the integral cabling or a proximity probe or an extension cable are connected to the prox connector on the driver. Excess proximity probe cables should be coiled up inside the housing/enclosure. **Do not cut any cable in a probe system, doing so will affect system accuracy.**

**Note: Only PRO DP series and DC series proximity products should be used for the PRO DD series drivers. Only Bently™ Compatible DX series products should be used with each other. Bently™ 3300XL products can be used with the PRO DX series. Substitute cables from other sources should not be used. PRO products are not electrically compatible with other sources and will affect system accuracy.**

All connector connections should be tight and secure. Snug the connector screw collar, applying 5 in-lbs (0.6 N-m) of torque.

**Note: Do not overtighten the probe cable connection. Do not exceed a torque of 8 in-lbs. (0.9 N-m). Too much torque can cause damage. Probe connectors must not touch any machine metal parts. Proper steps should be taken to isolate connectors from metal surfaces. Connector Protectors are available per request.**

Probes are provided with a threaded SST case. These can be mounted directly through the machine housing via threaded hole. When installing this way, proper clearance (1.5 x tip diameter; e.g. 1.5 x 11mm probe tip = 16.5mm clearance) around the probe tip must be provided. Refer to the figure below.

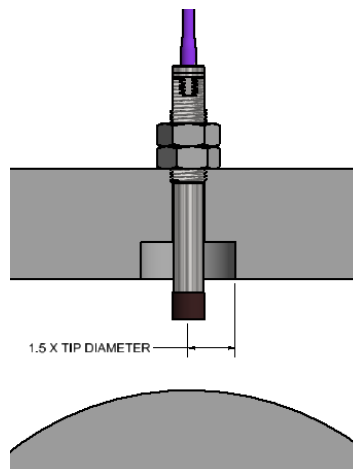

Figure 5 - Probe Tip Clearance

# SECTION 5: INSTALLATION

Standard mounting blocks and bushings are also available. Mounting blocks are available in anodized aluminum or phenolic material, all bushings are SST.

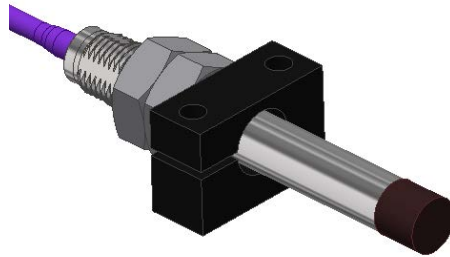

Figure 6 - Aluminum Clamping Mounting Block



Figure 7 - SST Mounting Bushings

# SECTION 5: INSTALLATION

## Electrical Connections

The driver has four terminal connections:  $V_T$ , COM, COM and OUT. The -24VDC power is connected to the  $V_T$  and COM terminals.

The COM (signal common or signal ground) terminal is isolated from the driver case. COM is not directly connected to the probe cable connectors.

The OUT terminal is the output signal connection, and is a negative voltage output, with the voltage moving more negatively (higher in magnitude) as the gap between the probe and the machine shaft increases. COM is used for the output as well.

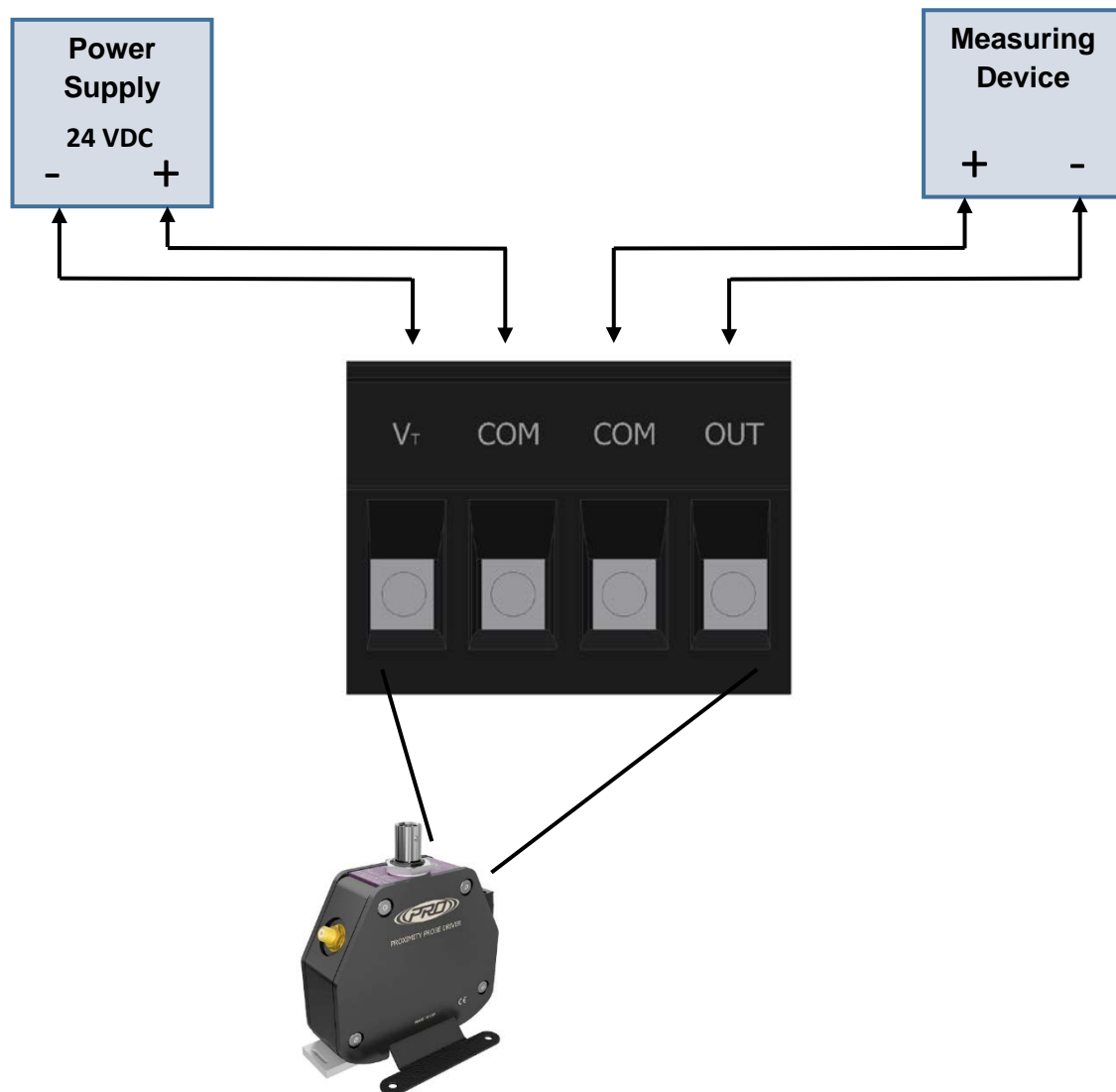

Figure 8 - 4 Wire Connection

**NOTE: Wiring Power Supply to COM-COM Terminals Will Damage the Driver**

# SECTION 5: INSTALLATION

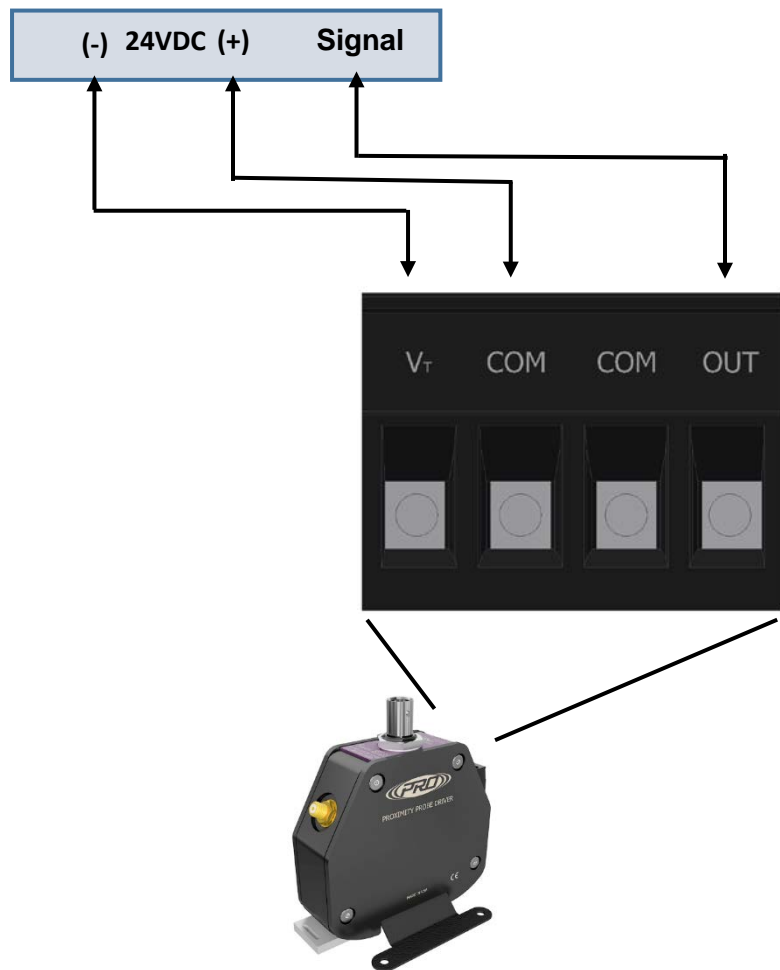

Figure 9 - 3 Wire Connection

**NOTE: Wiring Power Supply to COM-COM Terminals Will Damage the Driver**

# SECTION 5 : INSTALLATION

---

## Target Surfaces

The target material directly affects the output from the system. Drivers are calibrated for SAE 4140 steel. If the target material differs from SAE 4140 steel, the output will become non linear

For vibration monitoring of rotating shafts, the observed surface must have a roughness not to exceed 32 micro inches (<1 microns) and must be concentric. If the surface is rough or has discontinuities or there is excessive mechanical run-out, false vibration readings will result. To insure measurement accuracy, the target area should be at the circumference of a shaft and perpendicular to the probe tip.

Linear range may be reduced if the target/shaft diameter < 6 inches.

**NOTE: Shaft diameters should be uniform in target area, and free of keyways & oil slingers or mechanical damage.**

## Setup and Adjustment

When all connections to the driver have been made, and the probe is in place, apply power to the system. For applications where the only data of interest is vibration level, where measuring the gap is not important, the voltage at the OUT (signal output) terminal, relative to the COM (common) terminal should be -9.0 +/- 0.5 volts for a mid-range gap of 100 mils. Adjust the probe until this reading is obtained.

For applications where the actual gap needs to be measured, adjust the probe until a reading is obtained that reflects the desired initial gap setting.

# SECTION 6 : OPERATION

---

## Operation

A PRO DP Probe Assembly operates in combination with a PRO DP Probe Driver. For the Bently™ DX compatible series, the probe assembly can be interchanged with the Bently™ 3300XL Series components. The driver outputs a signal that is proportional to the gap between the probe tip and the target. The average gap corresponds to the DC component of the output. Vibration is measured by monitoring the DC variation of the signal simulating an AC component.

# SECTION 7: TROUBLESHOOTING

---

## Troubleshooting Chart

Problem	Recommended Action
-0.5 to -0.6 VDC Signal Output	Check Probe Cable / Ext Cable Connection
No Signal Output	Check Power Supply

**Note: For specific problem resolution, please call an Applications Engineer at 1-800-999-5290.**



# SECTION 8 : MAINTENANCE

---

## Maintenance

Once the proximity probe assembly have been installed, minimal maintenance will be required. Basic visual checks to ensure integrity and proper function should be made periodically.

## General

There are no customer replaceable parts. The proximity probe assembly has been designed for trouble-free service under normal operating conditions.

## Warranty

PRO will repair or replace any of our products under warranty so long as the product was not subjected to misuse, neglect, natural disasters, improper installation or modification which caused the defect.

## Contact Information

Connection Technology Center, Inc. (CTC)

7939 Rae Blvd., Victor, NY 14564

1-800-999-5290 (US & Canada) 1-585-924-5900 (International)

sales@ctconline.com      www.ctconline.com