

TSB1000/TSB2000

Fiberglass (TSB1000) or Stainless Steel (TSB2000) Switch Boxes, Triaxial Output, 4 Triaxial Sensors (12 channels)

SECTION 3 - JUNCTION BOXES
Switch Boxes

TSB1000 Series

Fiberglass Enclosure

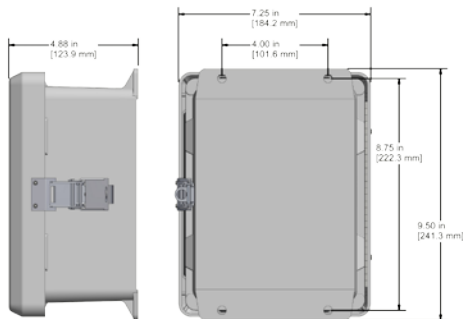
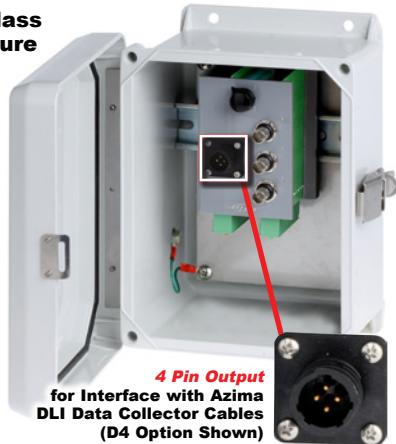

Product Features

Easily Switched Output for Triaxial Sensors

Access up to 4 Triaxial Sensors

Option for Continuous Monitoring Available

- Provides a switched output from remotely installed triaxial sensors to a data collector through 3 BNC jacks and 4 Pin connector (see options below)
- Accepts inputs from triaxial sensors
- Quick-release input terminal blocks

Specifications

	TSB1000	TSB2000
Inputs	5 Terminations per Triaxial Sensor (X, Y, Z, COM, GND)	
Switched Output	3 BNC jacks and 4 Pin connector (see options below)	
Continuous Output	Multi-pin connector for interface with online systems (optional) Requires JB933-1A	
Rating	NEMA 4X (IP66)	
Door Closure	Snap Latch	Twist Lock
Material	Fiberglass	Stainless Steel
Temperature Rating	-58° to 180° F (-50° to 82° C)	

TSB2000 Series

Stainless Steel Enclosure

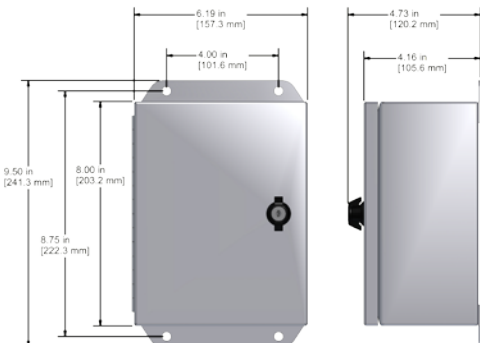

Ordering Information

TSB - **04** - -

Enclosure Type

1000 = Fiberglass Enclosure
2000 = Stainless Steel Enclosure

1001 = Fiberglass Enclosure, with continuous output option
2001 = Stainless Steel Enclosure, with continuous output option





Channels

04 = 4 Triaxial Sensors (12 Channels)



4 Pin Connector Compatibility

J4 = J4X Series connector compatible
G4 = G4X Series connector compatible
D4 = Azima DLI connector compatible
M4 = M4X Series connector compatible

Input Options

A = *User Defined 
B = **Conduit Fitting 
C = Cord Grips 
S = *Stainless Steel Cord Grips 

Output Options

A = None 
B = 1" Conduit Fitting 

Example Part Number: TSB1000-04-J4-CB

Fiberglass triaxial switch box, 4 triaxial sensor capacity, triple BNC output or CTC J4x series connector compatible, cord grip entry and conduit fitting exit

* No punch outs are provided in the enclosure for cable entry. User may install any fitting required.

** For use with rigid body conduit.

† Stainless Steel enclosure only.

Optional Accessories:

- JB933-1A (4 Required) output connector for online systems interface or TSB1001/TSB2001 Series. Note: End user is responsible for providing enclosure exit when using this option.

Backed by our Unconditional Lifetime Warranty

www.ctconline.com

