

VIBRATION ANALYSIS  
HARDWARE FOR  
*Portable Data*  
COLLECTION

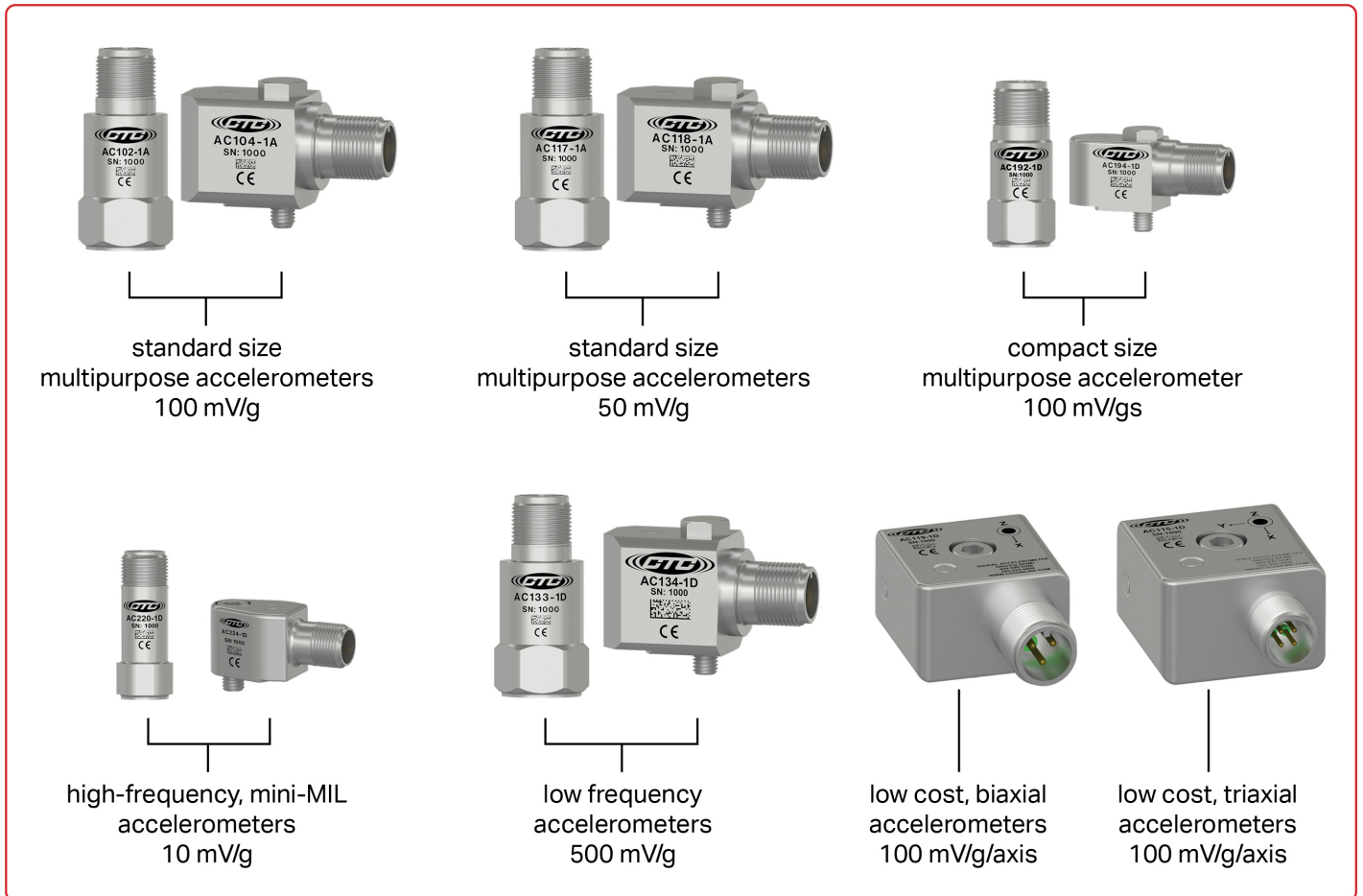

## Accelerometers

There are many options for accelerometers used in portable vibration measurement and data collection. The choice may depend on sensitivity (output), configuration (top exit, side exit, biaxial, triaxial), or just physical size. The application may be very specific and require a unique accelerometer for just that series of measurements. No matter what the requirement, CTC can provide a sensor based on fit, form, and function for trending, alarming, and diagnostics.



### Portable Data Collector Cables

The most important thing to remember about data collector cables is safety. Do not get wound up in your work! It doesn't matter if you are using a coiled cable or a straight cable; a break-away safety connector can be a lifesaver.

When a data collector cable gets wrapped around a rotating shaft, it can be hazardous. It could result in a life-threatening injury to the analyst or severe damage to the data collector. Photo number 1 shows a data collector cable that wrapped around a rotating shaft with no safety break-away connector. Note that not only is the cable destroyed, but both connectors have been ripped off the cable. Photo number 2 shows a data collector cable that wrapped around a rotating shaft; however, the presence of a break-away safety connector protected the analyst from injury and saved the data collector from being severely damaged.

## SF Connector

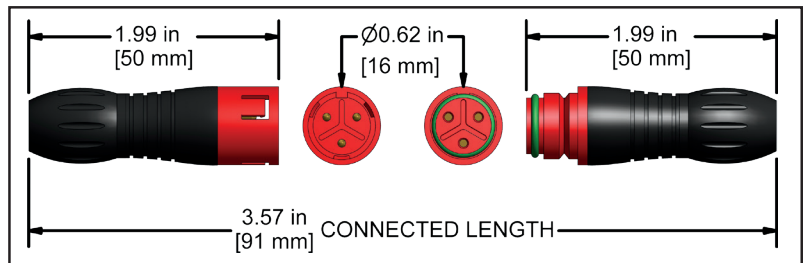
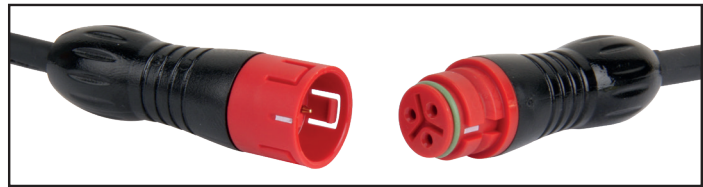

Dimensions are the same for the SFT, but it has 5 pins/sockets for tri-axial applications.



1 In this case, both ends of the cable were destroyed and a serious injury could have happened.



2 In this case, the safety connector saved the data collector and prevented a serious injury!









**CB104-C22-006-K2C-SF**  
Coiled Data Collector Cable with  
Break-away Safety Connector





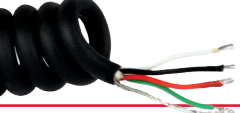



### Coiled Data Collector Cables

Coiled data collector cables are available in three fixed lengths. When extended, the cable lengths will be 6 ft (1,83 m), 10 ft (3,05 m), and 16 ft (4,88 m). All of the coiled cables feature a rugged black polyurethane jacket for maximum protection while maintaining flexibility. All coiled cables are halogen-free and meet the RoHS requirements.

Part	Use	Conductor Quantity	Shielding Method	Maximum Temperature	Cable Diameter	Wire Gauge	Ratings/Certifications
 <b>CB104</b>	Black Polyurethane, Heavy Duty, Coiled	2 Conductor	Braided Shield	250 °F (121 °C)	.210 in (5,3 mm)	AWG = 22	
<b>Compatible Connectors:</b> D2C, D2CG, D2D, D2H, E, F, FX90, J2C, K2C, L, R2C, Z							
 <b>CB108</b>	Black Polyurethane, Light Weight, Coiled	2 Conductor	Braided Shield	250 °F (121 °C)	.170 in (4 mm)	AWG = 24	
<b>Compatible Connectors:</b> D2C, D2CG, D2D, D2H, E, F, FX90, J2C, K2C, L, R2C, Z							
 <b>CB117</b>	Black Polyurethane, Heavy Duty, Coiled	4 Conductor	Braided Shield	250 °F (121 °C)	.210 in (5,3 mm)	AWG = 25	
<b>Compatible Connectors:</b> D3C, E2C, E3C, F2C, F3C, G3H, G4H1, J4C, L, Z							

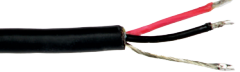
### Straight Data Collector Cables

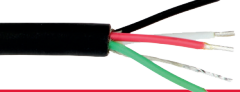
Straight data collector cables are available in multiple lengths, with popular sizes being 4 ft, 6 ft, and 10 ft. Longer lengths are available as required for balancing applications or remote access. All of the straight cables feature a rugged black polyurethane jacket for maximum protection and include a braided shield and an internal Kevlar or polypropylene fiber for maximum strength.

Part Number	Use	Conductor Quantity	Shielding Method	Maximum Temperature	Cable Diameter	Wire Gauge	Ratings/Certifications
 <b>CB103</b>	Black Polyurethane, Heavy Duty	2 Conductor	Braided Shield with Drain Wire	250 °F (121 °C)	.245 in (6 mm)	AWG = 20	
<b>Compatible Connectors:</b> D2C, D2CG, D2D, D2H, E, F, FX90, J2C, K2C, R2C							
 <b>CB110</b>	Black Polyurethane, Light Weight	2 Conductor	Braided Shield with Drain Wire	250 °F (121 °C)	.175 in (4,5 mm)	AWG = 20	
<b>Compatible Connectors:</b> D2C, D2CG, D2D, D2H, E, F, FX90, J2C, K2C, R2C							
 <b>CB105</b>	Black Polyurethane, Heavy Duty	4 Conductor	Braided Shield with Drain Wire	250 °F (121 °C)	.245 in (6 mm)	AWG = 20	
<b>Compatible Connectors:</b> D3C, E2C, E3C, F2C, F3C, G3H, G4H1, J4C							

## Cable and Connector Configuration

### Example Cordset: CB104-C555-006-D2C

Heavy Duty, black polyurethane jacketed coiled cable, with 5 Pin M12 connector to 2 socket MIL connector, 6 foot length extended

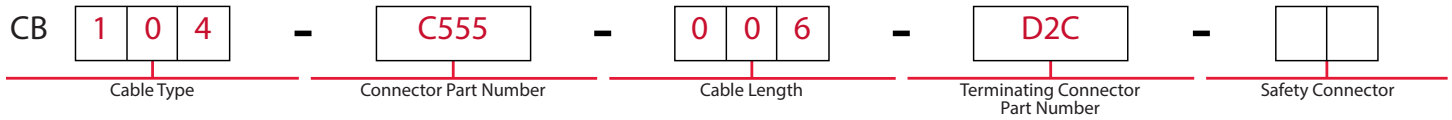
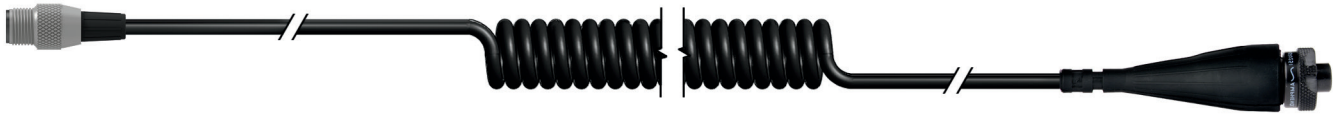

### Example Cordset: CB103-K2C-006-F-SF

Heavy Duty, black polyurethane jacketed cable, with 2 socket MIL connector to BNC plug connector, 6 foot length

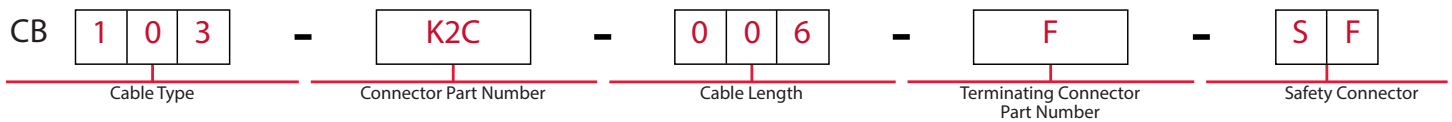

CTC is the world leader in cables and connectors for industrial vibration analysis. Cables and connectors form the foundation of our company and the Unconditional Lifetime Warranty demands cables and connectors that demonstrate industrial strength. Since 1995, CTC has placed thousands of data collector cables in the field, and they are still providing the same high-quality measurements for which they were designed. Based on sound engineering principles and real-life experience in the field, CTC cables and connectors are unsurpassed for reliability and quality. They are the choice for the Vibration Analyst that demands an accurate measurement the first time and every time.



**Compatible CTC Connectors\* for Your Data Collector**

**C3** 25 Pin D Subminiature Connector with Slide Lock, CSI Acceleration Input



CSI  
2110, 2115,  
2120, 2130

**C4** 25 Pin D Subminiature Connector with Slide Lock, SKF Acceleration Input



SKF  
Microlog, CMVA10  
CMVA55, CMVA60

**C22** 7 Pin LEMO® or Equivalent Connector, Acceleration Input



ENTEK/IRD  
Data Pac®, enpac™

**C66** 6 Pin Fischer® or Equivalent Connector



SKF  
CMXA Series, CMVX  
Diagnostic Instruments DI225,  
DLI DCA-20/DCA-31

**C84** 7 Pin Connector Acceleration Input



Adash  
A4300, A4900,  
A4910 & NRS VA3

**C314** 6 Pin ECTA Connector



ACOEM  
Falcon Analyzer

**C316** 7 Pin LEMO® Connector, Triaxial Acceleration Input



Data Pac®,  
enpac™

**C325** 6 Pin Fischer® or Equivalent Connector, Triaxial Acceleration Input



SKF  
CMXA Series,  
Diagnostic Instruments DI225,  
DLI DCA-20/DCA-31

**C330** 4 Pin LEMO® Connector, Single Channel Acceleration Input



CSI  
Speedvue

**C416** 7 Pin LEMO® or Equivalent Connector, Triaxial Acceleration Input



vb Series™  
Triaxial  
vb6 - vb8  
Ch. 1 = X  
Ch. 2 = Y  
Ch. 3 = Z

**C451** 7 Pin LEMO® or Equivalent Connector, Single Channel Acceleration Input



commtest\*  
vb6™, vb8™

**C555** 5 Pin M12 Connector, CSI Ch. A Acceleration Input



CSI  
2130/2140

**C560** 5 Pin M12 Circular Connector, Ch. 1 = Y, Ch. 2 = X, Ch. 3 = Z



CSI  
2130/2140  
\*When Used with a CTC Triax

**C561** 5 Pin M12 Circular Connector, Ch. 1 = X, Ch. 2 = Y, Ch. 3 = Z



CSI  
2130/2140  
\*When Used with a CTC Triax

**C562** 5 Pin M12 Circular Connector, Ch. 1 = Z, Ch. 2 = X, Ch. 3 = Y



CSI  
2130/2140  
\*When Used with a CTC Triax

**C618** 7 Pin Connector, Acceleration Input



Pruftechnik  
VIBExpert II

**F** BNC Plug **Molded**



**FX90** Right Angle BNC Plug **Epoxied**



\*A comprehensive listing of all connectors for portable data collection may be found on our website.

## CTC Connectors\*\* for Your Accelerometer

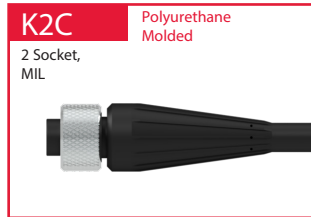
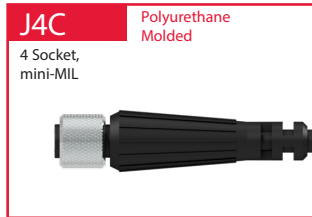
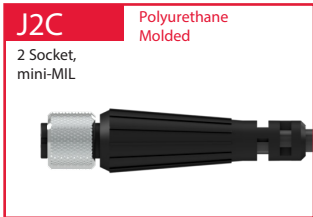
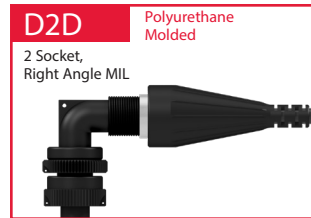
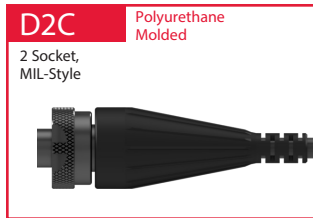

\*\*A comprehensive listing of all connectors for accelerometers may be found on our website.

## Adapters for Your Convenience

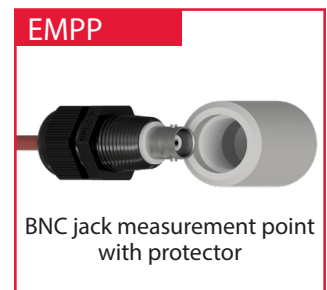
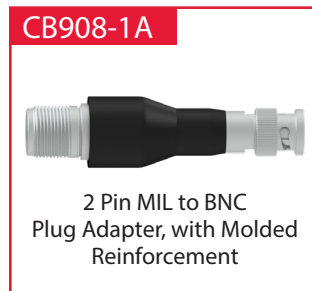

## Frequency Response/Mounting Techniques

The accuracy of your high-frequency response is directly affected by the mounting technique that you select for the sensor. In general, the larger the mounted surface area contact between the sensor and the machine surface, the more accurate your high-frequency response will be. High-frequency response is based on the sensor specified as well as the method of attachment (together as a system).

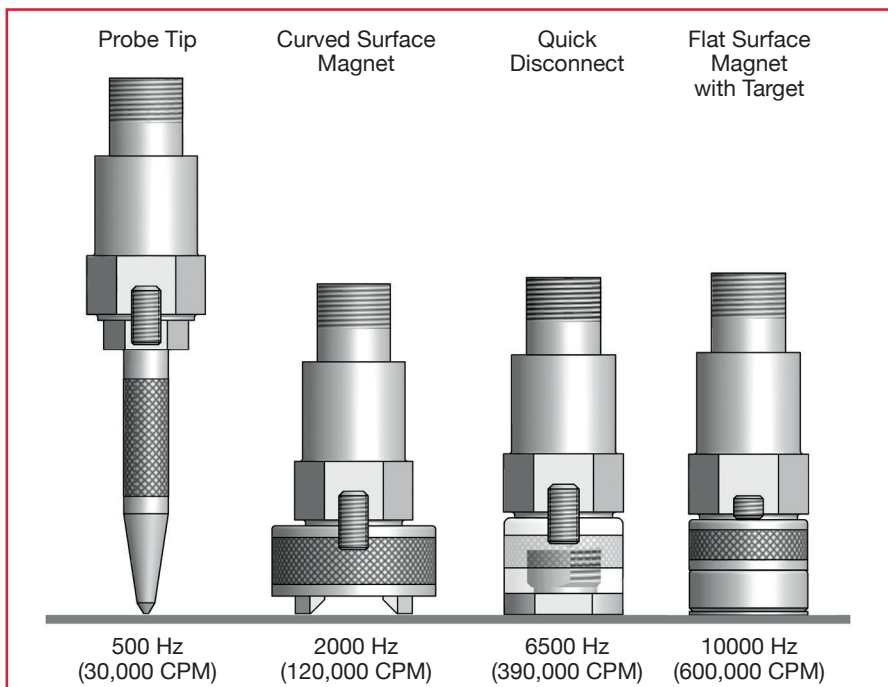

Maximum Frequency Response (within +3dB)

All of the illustrated techniques may accurately obtain low-frequency response because low frequency is not based on the mounting system resonance of the sensor and attachment method. The ability to measure low-frequency vibrations will be a function of the sensor's specified capability to measure a given low frequency, and not dependent on the mounting technique chosen.

The response chart offers a general guideline for the range of portable mounting techniques available and the corresponding high-frequency response expectations.

## Probe Tips Allow Easy Access to Measurement Points

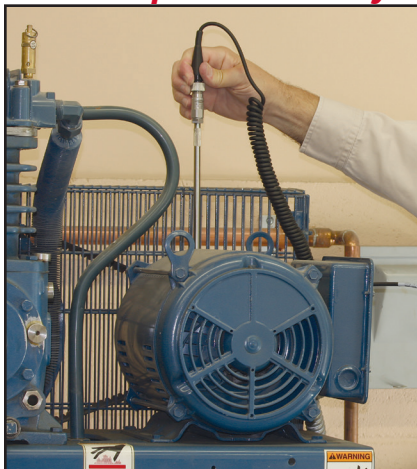

CTC's MH119 series probe tips connect directly to any standard 1/4-28 threaded accelerometer. Each probe is made of sturdy 300 stainless steel to ensure long term survival in harsh factory environments. Tips allow easy access to measurement points that are in difficult to reach areas such as cooling fins and guards.

Part Number	Length (A)
MH119-1A	2.5 in. (63,5 mm)
MH119-2A	4.0 in. (101,6 mm)
MH119-3A	8.0 in. (203,2 mm)





**Rare Earth Magnetic Bases — Curved Surfaces**

The MH214-3A Easy Positioning Curved Surface Magnet can be adjusted so that the two poles of the magnet can be parallel to the data collector cable, perpendicular to the data collector cable, or in any rotational reference to the data collector cable that you like. An aluminum hex wrench comes packaged with each magnet for easy adjustment.

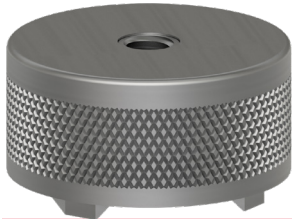

For Use With AC116-1A/AC216-1A Magnet Mount Accelerometer



magnet feet parallel with sensor cable



magnet feet perpendicular with sensor cable



magnet feet rotated with sensor cable

**MH112-1A**  
 Pull Strength  
 30 lbs.  
 Mounting Stud:  
 1/4 - 28



**MH114-3A**  
 Pull Strength  
 50 lbs.  
 Mounting Hole:  
 1/4 - 28



**MH115-2A**  
 Pull Strength  
 95 lbs.  
 Mounting Hole:  
 1/4 - 28



**MH128-1A**  
 Pull Strength  
 30 lbs.  
 Mounting Hole:  
 1/4 - 28



**MH137-1A**  
 Pull Strength  
 10 lbs.  
 Mounting Stud:  
 1/4 - 28



**MH140-1A**  
 Pull Strength  
 120 lbs.  
 Mounting Hole:  
 1/4 - 28



**MH142-1A**  
 Pull Strength  
 50 lbs.  
 Mounting Hole:  
 M8



**MH147-1A**  
 Pull Strength  
 50 lbs.  
 Mounting Hole:  
 M6

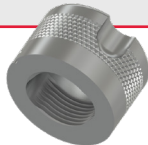
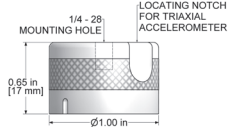
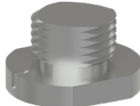
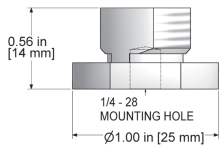

**Accelerometer Quick Disconnects**

<p><b>MH107-1A</b>                  Mounting Hole:                  1/4 - 28</p>  <p>Quick Disconnect Receptacle</p> 	<p><b>MH107-1B</b>                  Mounting Hole:                  1/4 - 28</p>  <p>Quick Disconnect Mounting Stud</p> 
---	--

CTC's Accelerometer Quick Disconnects are ideally suited for triaxial sensor use.

They feature a convenient locating notch and an easy, quarter-turn connection.

**Rare Earth Magnetic Bases — Flat Surfaces**

**MH103-1B**



Pull Strength  
 40 lbs. Mounting Stud:  
 1/4 - 28

**MH104-1B**



Pull Strength  
 60 lbs. Mounting Stud:  
 1/4 - 28

**MH122-1A**



Pull Strength  
 40 lbs. Mounting Hole:  
 1/4 - 28

**MH123-1A**



Pull Strength  
 60 lbs. Mounting Hole:  
 1/4 - 28

**MH136-1A**



Pull Strength  
 10 lbs. Mounting Stud:  
 1/4 - 28

**MH133-1A**



Magnet Target