



# UNIVERSITY

## LEVEL 3, LESSON 7

FREQUENCY LIMITATIONS  
RESULTING FROM MOUNTED  
RESONANCE OF AN  
ACCELEROMETER

# Introduction



Welcome to **Level 3, Lesson 7 – Frequency Limitations Resulting From Mounted Resonance Of An Accelerometer**, part of CTC's free online vibration analysis training series.

We hope you enjoyed and benefitted from the previous course and will continue to build your vibration analysis knowledge as you progress through Level 3.

*Frequency Limitations Resulting From Mounted Resonance Of An Accelerometer is created and presented by CTC for complimentary educational use only. This training presentation may not be edited or used for any other purpose without express written consent from CTC.*

# Training Objectives

Upon completion of this lesson, you will understand:

- ① The principles of mounting resonance
- ② How mounting resonance can negatively impact the usable frequency range of an accelerometer
- ③ How to avoid mounting resonance when installing your accelerometer

# Overview

Accelerometers are some of the best diagnostic sensors available today to measure machine vibration and assist the trained analyst in the diagnosis of a potential problem developing with the machine.

Faults such as imbalance, misalignment, bearing failure, gear failure, flow disturbances, or blade passing disturbances are just some of the many problems that can be detected with an accelerometer.

These faults are sensed by the accelerometer through surface-to-surface contact with the machine.



# Overview



Transmission of vibration from the machine to the accelerometer is only as good as the mounting of the accelerometer allows



Poor mounting methods can severely limit the ability of the accelerometer to measure those vibrations that it was designed for



Typical industrial accelerometers have usable frequency ranges as high as 15 kHz (15,000 cycles/second) or 900,000 CPM (cycles/minute)



To achieve full use of this upper frequency limit, the mounting must be very good to avoid a characteristic known as mounting resonance

# Overview

Mounting resonance is a direct result of the accelerometer's natural frequency and occurs as the result of reduced stiffness or increased mass.

This is probably best described by viewing the formula where the stiffness is expressed in the numerator and the mass is expressed in the denominator:

$$f_n = \frac{1}{2} \pi \sqrt{k/m}$$

●  $f_n$  = natural frequency (Hz)

●  $k$  = stiffness (lb/in)

●  $m$  = mass

● **mass** = weight (lb)/gravity (386.1 in/sec<sup>2</sup>)



# Accelerometer – Natural Frequency

Initial design and construction of the accelerometer involves a much higher natural frequency than the usable range. This allows for tolerances to be placed on the usable range of  $\pm 5\%$ ,  $\pm 10\%$ , or  $\pm 3$  dB.

Stiffness is accomplished by the rigid mounting of a piezoelectric element inside of the accelerometer. The size of the mechanical mass used to exert force on the piezoelectric element and provide the source of excitation is based on the desired frequency output of the accelerometer.

A lighter mass will produce a higher frequency output, and a heavier mass will produce a lower frequency output.

A lighter mass will produce less force, and a heavier mass will produce more force, so the size of the mass is carefully balanced to provide both output frequency and amplitude characteristics.

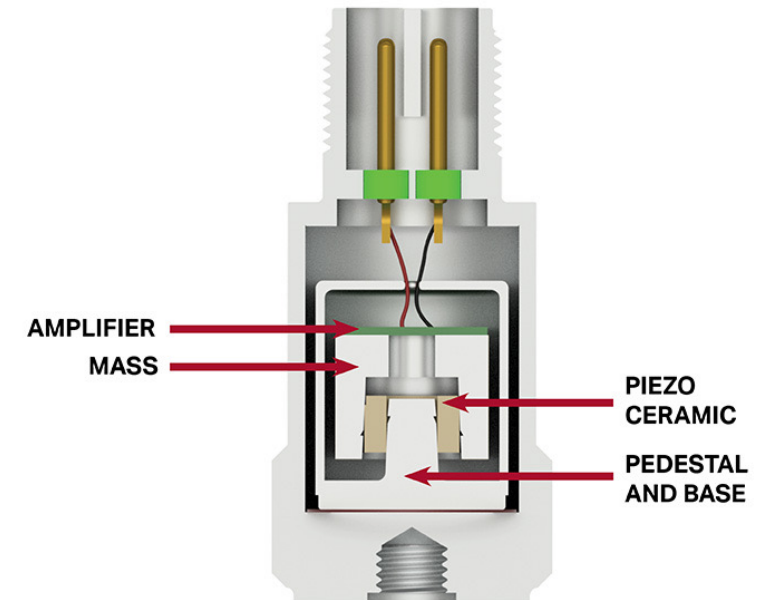

# Accelerometer – Natural Frequency

This is a typical natural frequency response for an accelerometer.

The regions of transmission, amplification due to resonance, and isolation have been marked for clarity.

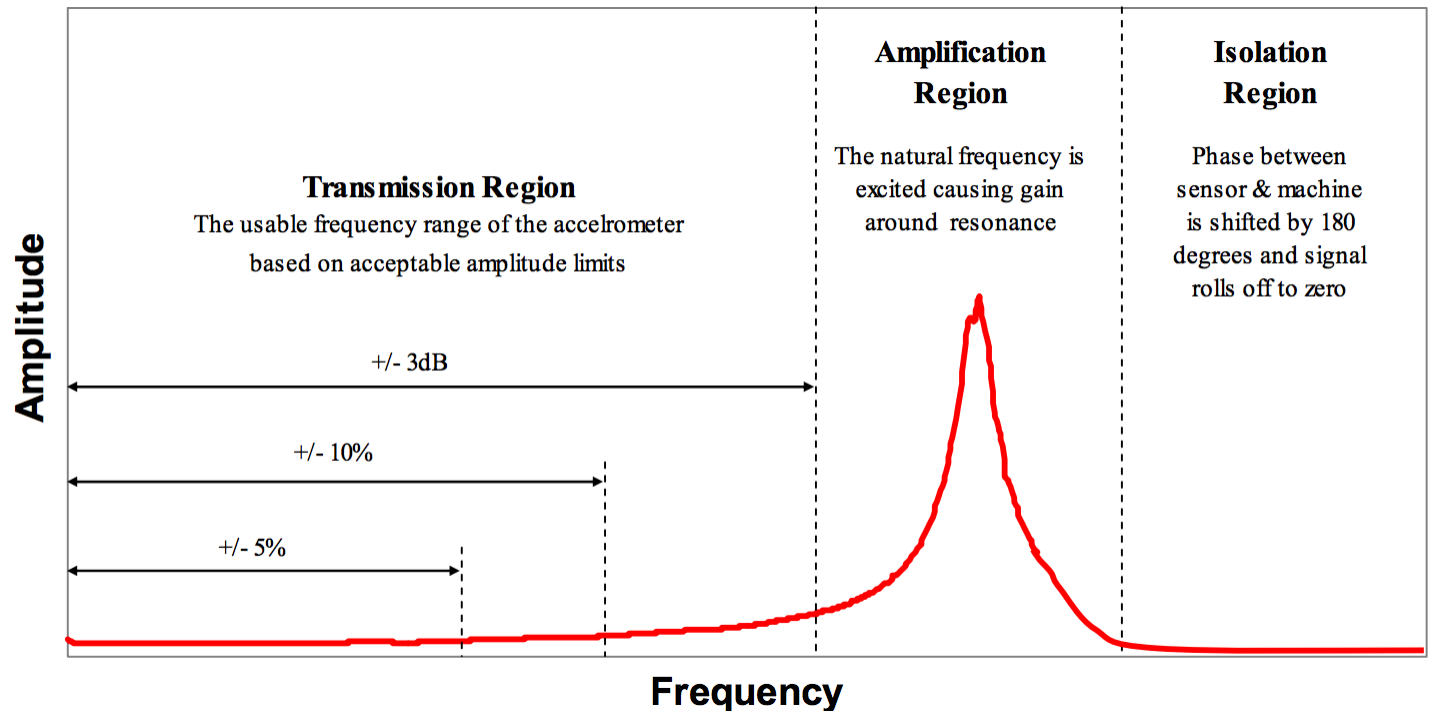



# Accelerometer – Functionality

The transmission region is the functional region for the accelerometer. The degree of accuracy within this region is described by the amplitude tolerances of  $\pm 5\%$ ,  $\pm 10\%$ , and  $\pm 3$  dB. Although  $\pm 5\%$  has the best amplitude tolerance, it will also have a limited transmission region.

The largest transmission region will occur at the  $\pm 3$  dB amplitude tolerance – put into linear units this is approximately -30% or -40% in amplitude tolerance. Initially the  $\pm 3$  dB tolerance would seem to be excessive, but it is used over and over in the industry with a great deal of success.

These tolerances are produced during the manufacture of the accelerometer and are essentially fixed for the life of the accelerometer provided it does not get damaged. Since most programs are based on trended history, not absolute amplitude, the application of  $\pm 3$  dB tolerance is acceptable.

# Accelerometer – Functionality

- The amplification region is the direct result of the natural frequency and occurrence of resonance.
- This region can produce very large gains in the vibration signal. This can cause the vibration levels to appear much higher than they actually are.
- Typically, the data in the amplification region is not used. There are some techniques that use the amplification region to achieve early warning of mechanical faults through high frequency detection, but they will not be discussed at this time and are best left to various manufacturers of vibration instrumentation that are applying them in several different application programs.
- The isolation region is an area of phase shift and signal loss. A phase shift of  $180^\circ$  occurs after passing through resonance. Minimal vibration is measured in this region, and essentially data is lost when operating above the natural frequency.

# Mounted Resonance



Under ideal circumstances, the accelerometer mounting method should provide total use of the the transmission region.

Although this is an excellent goal for any analyst to have, it is totally dependent on the mounting method used.

Remember, the natural frequency of an accelerometer is based on its stiffness and mass, and anything that modifies these characteristics during the mounting of the sensor will shift its natural frequency.

Unfortunately, this shift in resonance always reduces the usable range of the accelerometer.

The accelerometer is not broken or any less worthy than it was designed, it is just altered during the mounting process.

# Mounted Resonance

There are several different mounting methods available – two of these methods are used much more frequently than the others.

This is a manufacturer's chart indicating some of these methods, and the expected useable frequency ranges for the transmission of machine vibrations to the accelerometer.

The following slides will look at the resulting changes in mounted resonance for the two most popular mounting methods.

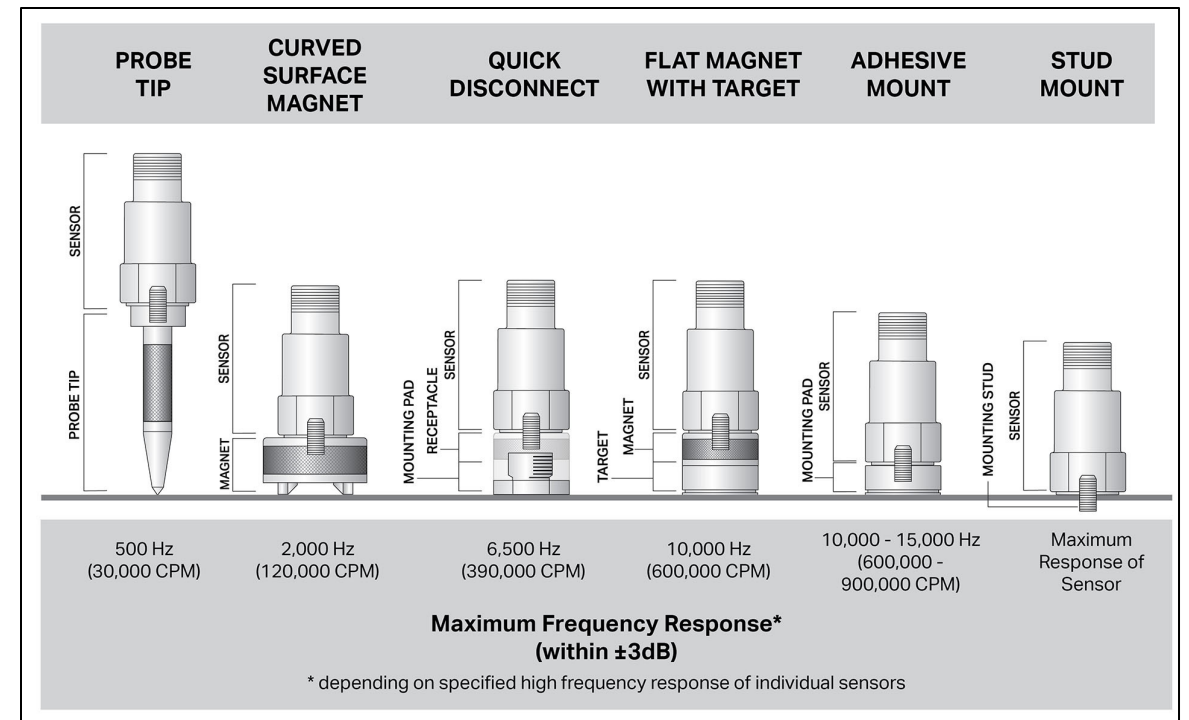

# Mounted Resonance – Curved Surface Magnet



The curved surface magnet, sometimes referred to as a two-bar or two-pole magnet, is probably the most popular method of mounting for portable vibration measurements.



It fits well on curved surfaces like bearing housings and quickly lets the vibration analyst move it from the vertical, horizontal, or axial location of each bearing.



Typically, the curved surface magnet will offer usable transmission of vibration up to 2,000 Hz.

# Mounted Resonance – Stud Mounting



Stud mounting requires a smooth machined surface with a drilled and tapped hole.



This type of mounting is best suited to permanent vibration monitoring where an accelerometer will be installed and left on the machine for every location that vibration will be measured.



This is often referred to as the reference mounting because it will typically provide a usable transmission of vibration up to the limits of the accelerometer.



# Mounted Resonance – Analysis Of The Two Mounting Methods



To analyze these two methods, there needs to be some vibration instrumentation and techniques employed to simulate a vibrating machine.

We will look at these on the following slides.



# Mounted Resonance – Analysis Of The Two Mounting Methods



A vibration shaker with a calibrated standard reference accelerometer built into it will be used to simulate the machine vibration.

It will provide controlled vibration disturbance across the entire frequency range of the test.

The reference accelerometer is considered the input and is compared to the accelerometer being tested (output).

The shaker is limited to 10,000 Hz maximum frequency range.

# Mounted Resonance – Analysis Of The Two Mounting Methods

A function generator will be used to drive the shaker with random noise and simulate the multitude of vibration disturbances common to industrial machines.

It is very rare to have a machine generate only one vibration or frequency disturbance, and the application of random noise has a better simulation of industrial machinery vibrations and frequency disturbances.

An accelerometer is used to test employing the desired mounting method on the shaker.



# Mounted Resonance – Analysis Of The Two Mounting Methods

A dynamic signal analyzer will be used to capture the data and display the results in five formats:



**The power spectrum (FFT) of the reference accelerometer**  
indicating amplitude vs. frequency (input)



**The power spectrum (FFT) of the test accelerometer**  
indicating amplitude vs. frequency (output)



**The frequency response**  
generated by dividing the output of the test accelerometer by the input of the reference accelerometer. The ideal response in amplitude is a value of one (unity gain), but it will also indicate the gain produced at resonance.



**The coherence**  
indicating the percentage of output of the test accelerometer that is related to the input of the reference accelerometer. This is often referred to as linear causality.



**The phase between the two accelerometers**  
The reference accelerometer and test accelerometer should be in phase with each other in the transmission region and prior to resonance. After resonance, the two sensors will be out of phase with each other.

# Mounted Resonance – Analysis Of The Two Mounting Methods

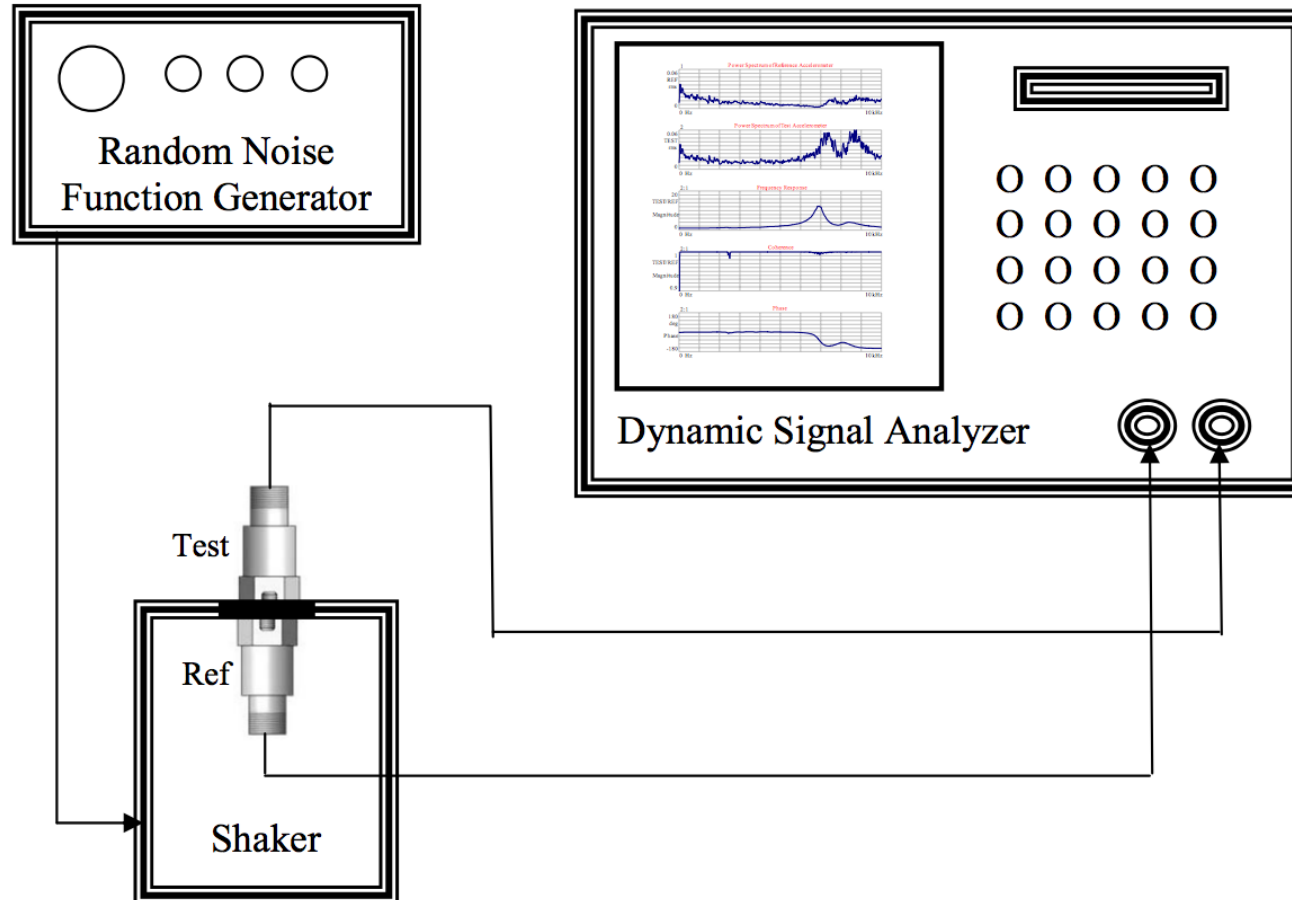

# Mounted Resonance – Analysis Of The Two Mounting Methods

As shown in the diagram on the previous slide, the random noise function generator supplies the electrical signal to drive the shaker.

The reference accelerometer is built into the shaker, and the test accelerometer is mounted on top of the shaker.

The signal for the reference accelerometer is applied to channel one of the dynamic signal analyzer, and the signal for the test accelerometer is applied to channel two of the dynamic signal analyzer.

Channel one and the reference accelerometer will be considered the input for testing purposes. Channel two and the test accelerometer will be considered the output for testing purposes.

The mounting method under test will be applied between these two accelerometers and the output compared to the input.

# Mounted Resonance – Stud Mounting

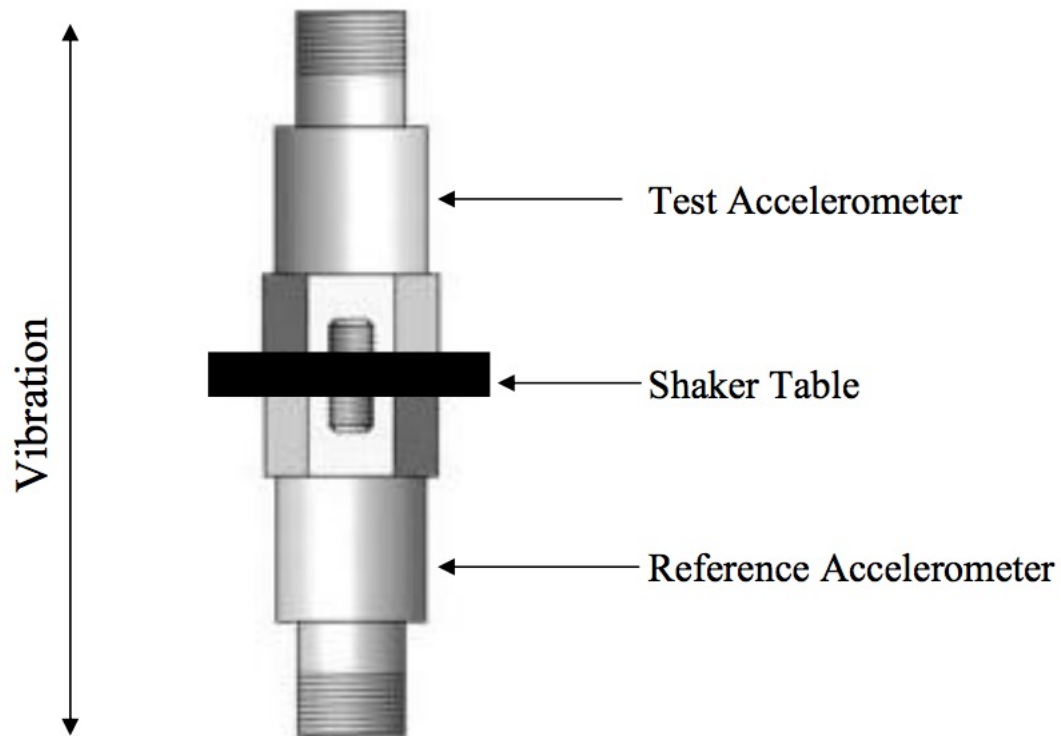

Stud mounting is accomplished with a drilled and tapped hole using a threaded fastener between the accelerometer and the machine.

During testing and calibration, this is often referred to as back-to-back mounting.

The accelerometers are essentially bolted together on the shaker, with the shaker table in the middle between them.

This is an illustration of the back-to-back mounting technique.

# Mounted Resonance – Stud Mounting



The application of random noise from 0 - 10,000 Hz will cause the shaker to oscillate (vibrate) both sensors simultaneously. In this manner the two sensors can be compared to each other with the dynamic signal analyzer.

The following charts represent results obtained with the back-to-back mounting method.



# Mounted Resonance – Stud Mounting

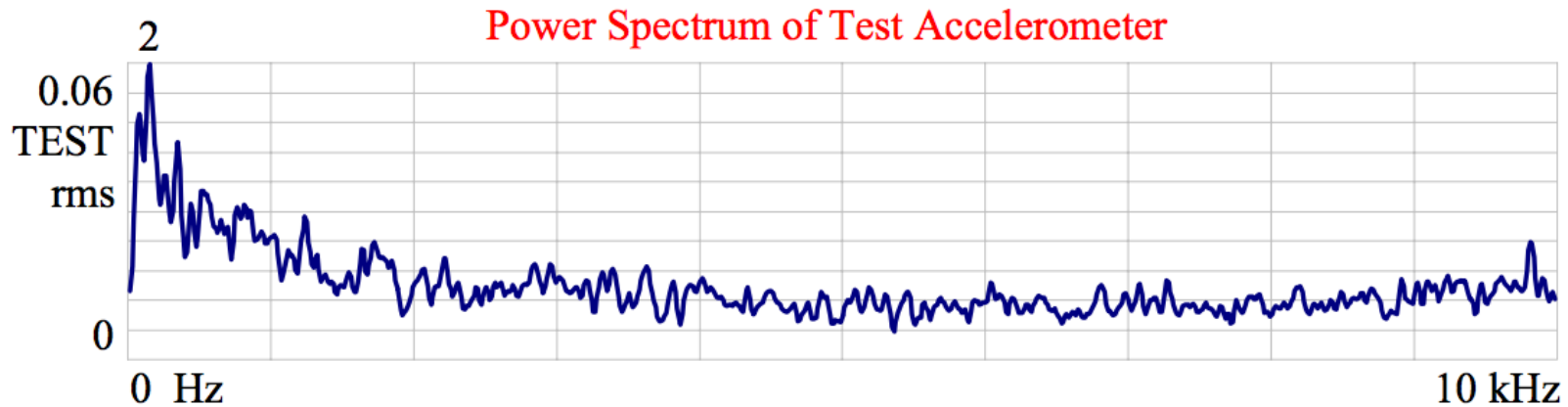
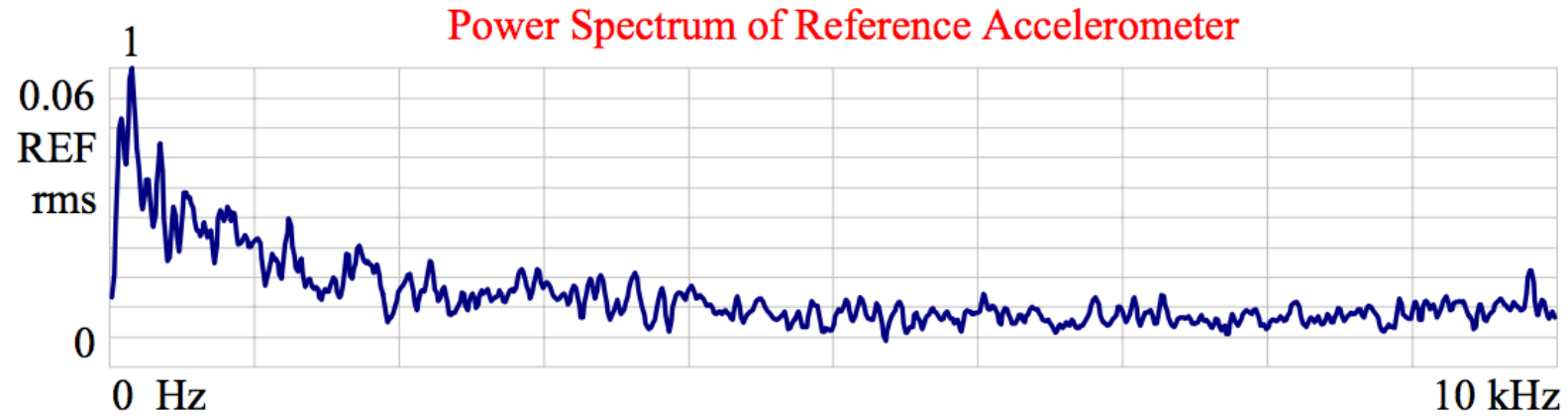

# Mounted Resonance – Stud Mounting

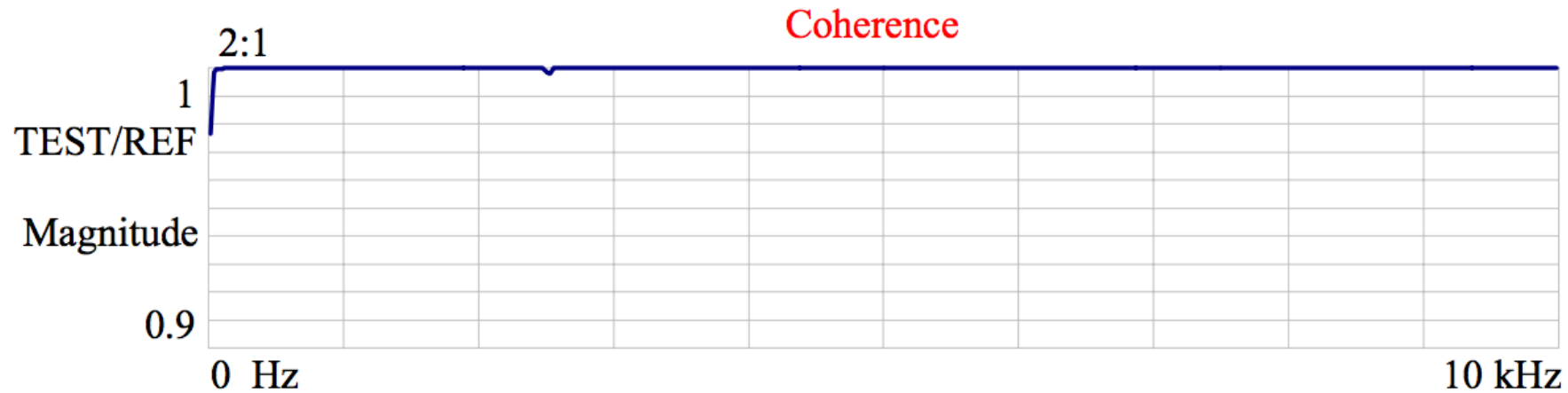
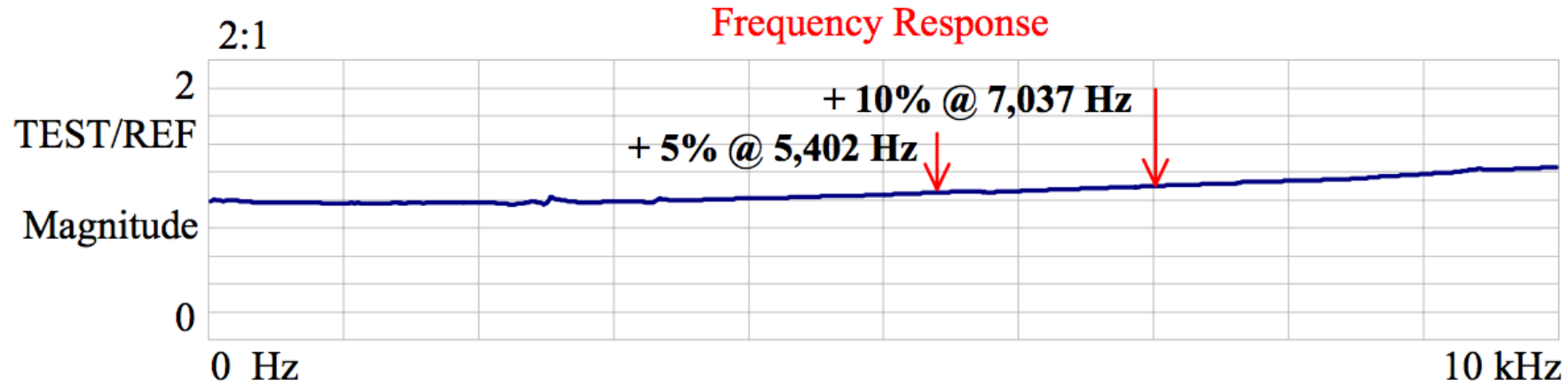

# Mounted Resonance – Stud Mounting

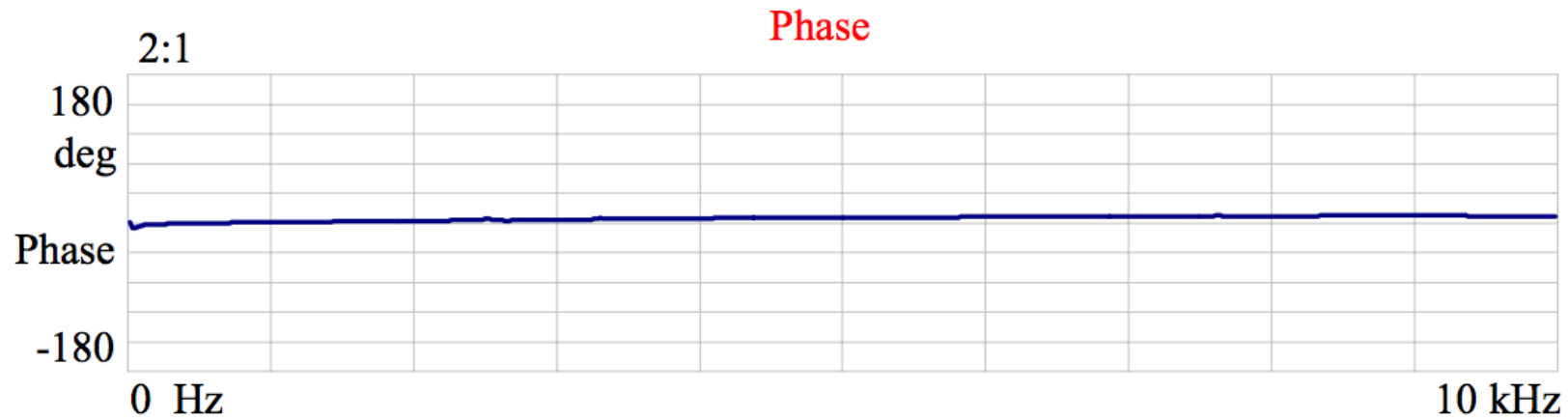

# Mounted Resonance – Stud Mounting

## Power Spectrums

Analysis of the data measured in the previous charts indicates the power spectrums for the reference accelerometer and test accelerometer are almost identical.

## Frequencies & Amplitudes

These are well matched in both power spectrums. The frequency response approximates a gain of one, with the  $\pm 5\%$  limit at 5,402 Hz and the  $\pm 10\%$  at 7,037 Hz.

## Transmission Range

The  $\pm 3$  dB limit was never exceeded. This provides a transmission range within the 3 dB limit, up to at least 10,000 Hz and probably higher if it was within the scope of the measurement.

## Coherence

The coherence is very good and provides an indication that 100% of the vibration measured by the test accelerometer was caused by the shaker and reference accelerometer.

## Phase

The two sensors are in phase with each other and indicate that they are operating below resonance.

# Mounted Resonance – Magnet Mounting

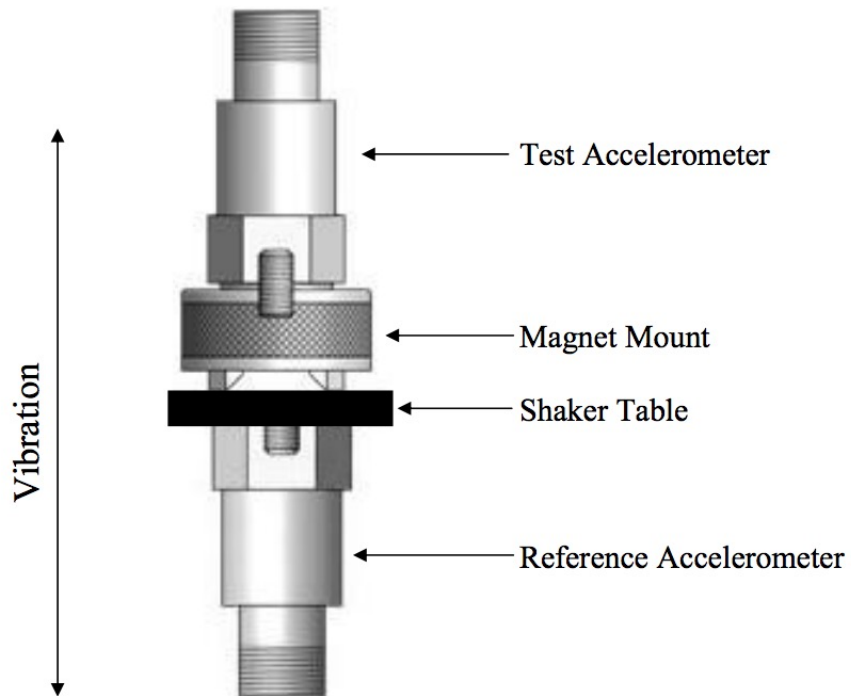

The curved surface magnet has the accelerometer attached to it by a threaded stud. However, when the assembly is placed on the machine to measure vibration, the attachment to the machine is accomplished by two magnetic bars.

Transmission through the magnet is accomplished by two lines of contact and the pull force of the magnet. This provides limited surface area and stiffness for the assembly. The magnet itself adds significant mass to the accelerometer. The loss of stiffness and the increase in mass will reduce the resonant frequency of the sensor and magnet combination.

This mounted resonance will be much lower than the capabilities of the accelerometer without the magnet. This illustration shows the magnet mount and reference accelerometer for testing purposes.

# Mounted Resonance – Magnet Mounting



The application of random noise was again applied to the shaker over the frequency range of 0 – 10,000 Hz. The same measurements were made on the magnet mounting that were previously made on the stud mounting.

The following charts represent the results obtained with the magnet mounting method.

# Mounted Resonance – Magnet Mounting

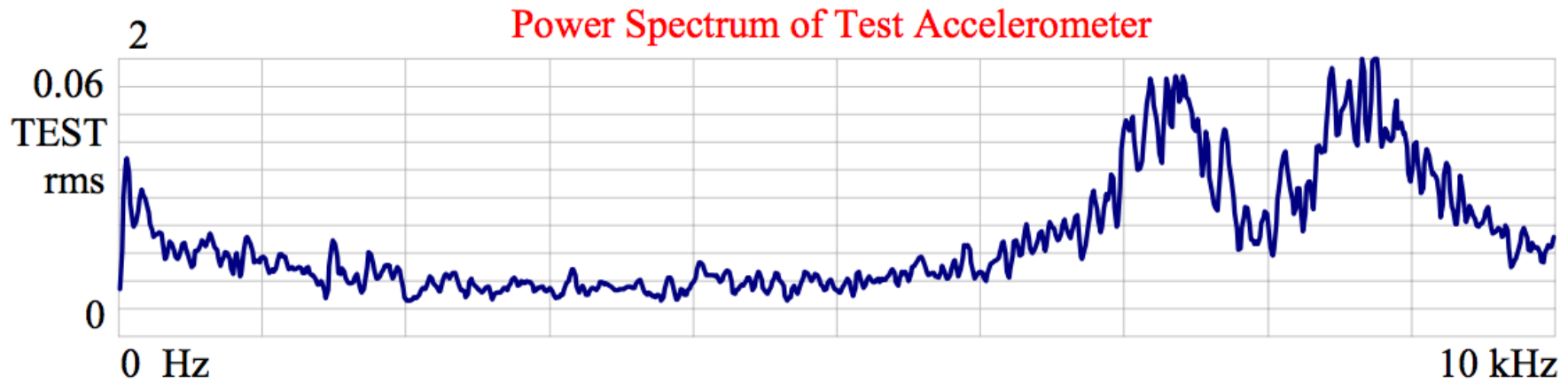
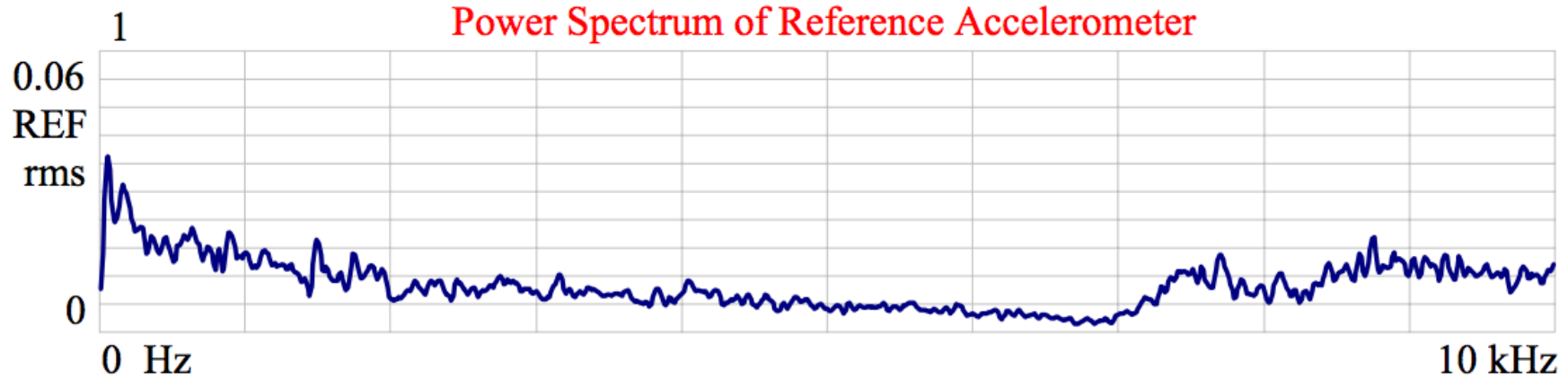



# Mounted Resonance – Magnet Mounting

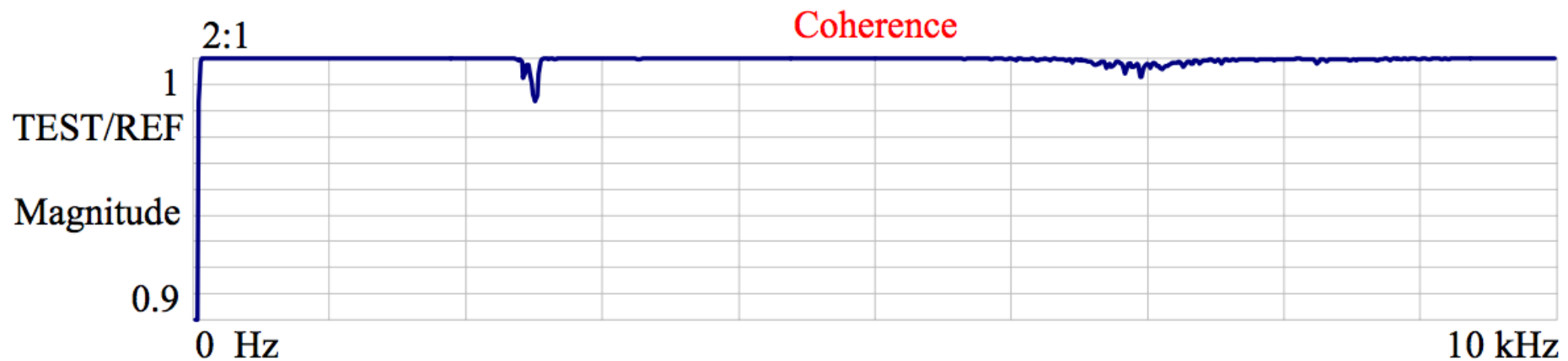
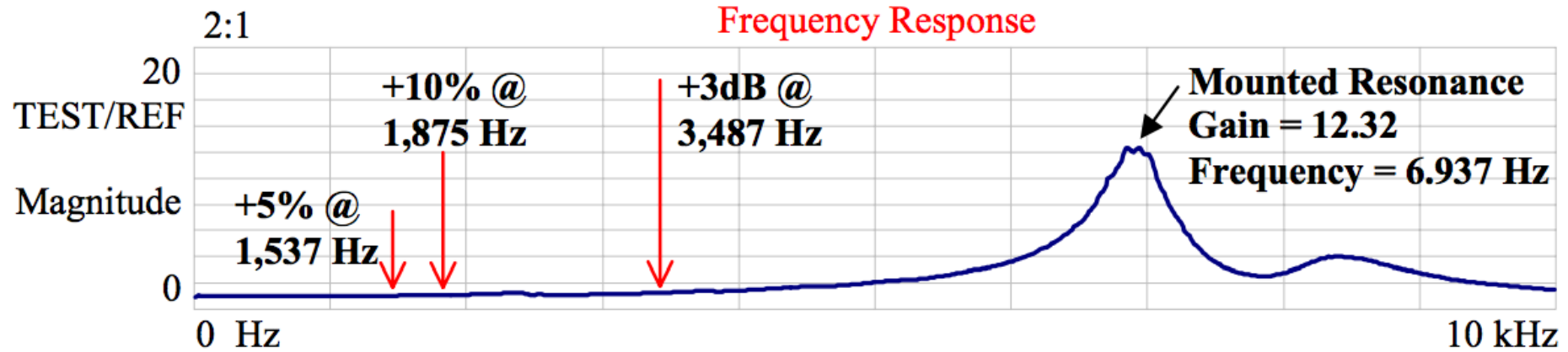

# Mounted Resonance – Magnet Mounting

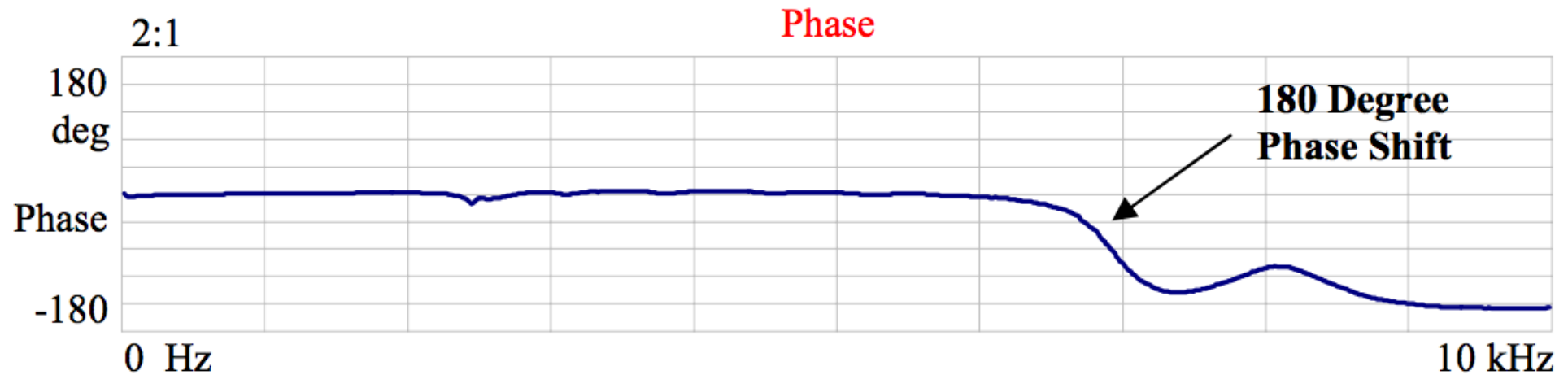

# Mounted Resonance – Magnet Mounting

## Power Spectrums

Analysis of the data measured in the previous charts indicates that the power spectrums for the reference accelerometer and test accelerometers are very different.

## Amplitudes

Amplitudes are significantly higher in the test accelerometer above 5,000 Hz.

## Frequency Response

The frequency response is limited to the transmission range below the resonant frequency of 6,937 Hz. The  $\pm 5\%$  limit is 1,537 Hz, the  $\pm 10\%$  limit is 1,875 Hz, and the  $\pm 3$  dB limit is 3,487 Hz.

# Mounted Resonance – Magnet Mounting

## Resonant Frequency

The resonant frequency at 6,937 Hz has a gain of 12.32. If an amplitude of 1 inch/second were applied to the shaker at 6,937 Hz, the mounting resonance would cause a vibration measurement of approximately 12.32 inches/second on the output of the test accelerometer.

## Coherence

The coherence is very good and provides an indication that 98% of the vibration measured by the test accelerometer was caused by the shaker and reference accelerometer. Keep in mind that the amplitude of the signal is displayed in the frequency response and that the coherence is the measurement of causality.

## Phase & Resonance

The two sensors are in phase with each other below 6,937 Hz, and out of phase with each other above 6,937 Hz. Above resonance, if the test accelerometer is measuring a positive going signal, then the reference accelerometer is measuring a negative going signal. Essentially, the two signals will cancel each other out above resonance because they are out of phase by 180°.

# Conclusion

It is difficult to match the typical performance in the diagram on slide 8 with the actual results on slides 29 – 31.

Small inconsistencies in the mounting methods, system performance, and broad frequency response at resonance in the actual measurement prevent ideal correlation to the typical performance characteristics. These small inconsistencies are faced daily by the vibration analyst.

However, it does not take away from the testing. In actuality, the typical performance is well represented by the outcome of the testing.

# Conclusion

Back-to-back mounting of the two sensors provided a very wide transmission range, and even at the 10,000 Hz, the  $\pm 3$  dB limit was not exceeded.

This clearly indicates that stud mounting the accelerometer to the machine would give the best possible frequency response and is an ideal method for permanently mounted accelerometers.

A flat, prepared machine surface with a drilled and tapped hole to mount the accelerometer stud should provide the full frequency range of the accelerometer's design specification.

# Conclusion

Recommendations for curved surface magnet mounting are typically limited to a maximum of 2,000 Hz.

Testing for this investigation yielded a  $\pm 3$  dB limit of 3,487 Hz. This improved result is probably caused by the flat surface of the shaker table.

The two bars in the magnet had significantly more surface area and better stiffness on a flat surface than the lines of contact that would be experienced on an actual curved bearing housing.

The mounting resonance was identified and the reduced transmission range was apparent. Although the curved surface magnet is very useful and convenient for portable vibration measurements, the user needs to be aware that the frequency response is limited and measurements at mounted resonance will be higher than expected, and measurements above resonance will be lower than expected and eventually approach 0.

# Conclusion

There are other portable mounting methods that will provide increased transmission ranges, and a quick disconnect or flat surface magnet are excellent examples.

However, each of these designs require surface preparation and the mounting of a permanent target to achieve as much surface-to-surface contact and stiffness as possible.

If portable data collection requires the measurement of vibration above 2,000 Hz then one of these alternatives should be considered.



# Why Choose CTC?



Superior durability



Accuracy and performance



Industry's best lead times



Knowledgeable staff



Industry leading warranties

# Connect With CTC

We look forward to hearing from you

