



VIBRATION ANALYSIS HARDWARE



**JB130 Series Switch Box
48 Triaxial Sensor Inputs
Product Manual**

TABLE OF CONTENTS

- Introduction.....3
- Product Description.....3
- Product Dimensions.....4
- Mounting Instructions.....5
- Conduit Entry6
- Grounding7
- Sensor Installation9
- Post-Installation Testing..... 12
- Maintenance 13
- Warranty & Refund 14



INTRODUCTION

CTC switch box solutions allow for the monitoring of remotely-mounted vibration sensors, which would otherwise be restricted to human access due to safety considerations.

JB130 Series Switch Box Overview: *Twenty-four to 48 sensor inputs (72 to 144 measurement channel outputs), fiberglass enclosure*

The extended capacity JB130 Switch Box is a common cable termination point for bringing compatible cables for triaxial sensors into a switch box for routine data collection with portable data collectors. JB series enclosures are designed to have field-input cabling installed behind the board. Four flip-down panels allow the user to wire connections on location. The JB series also features an IEPE bias indicator light built into the box itself, which can be used to indicate errors in the field wiring or the sensor.

Rated for NEMA 4X (IP66), the JB130 is resistant to hose-directed fluid and corrosion. The box can also withstand harsh environments, including temperatures ranging from -58°F to 180°F (-50°C to 82°C). A snap latch is installed on the door, allowing the box to be sealed from the elements when not in use.

If a continuous output application is desired, that can be easily accomplished by purchasing the optional CTC accessory "T" plug, part number JB933-1A.



PRODUCT DIMENSIONS

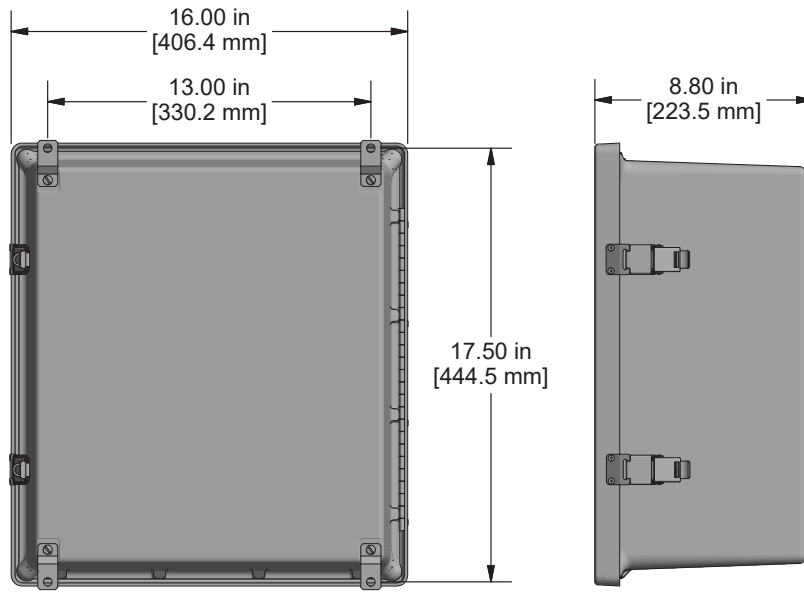

Rear View

Side View

Figure 1. Dimensions

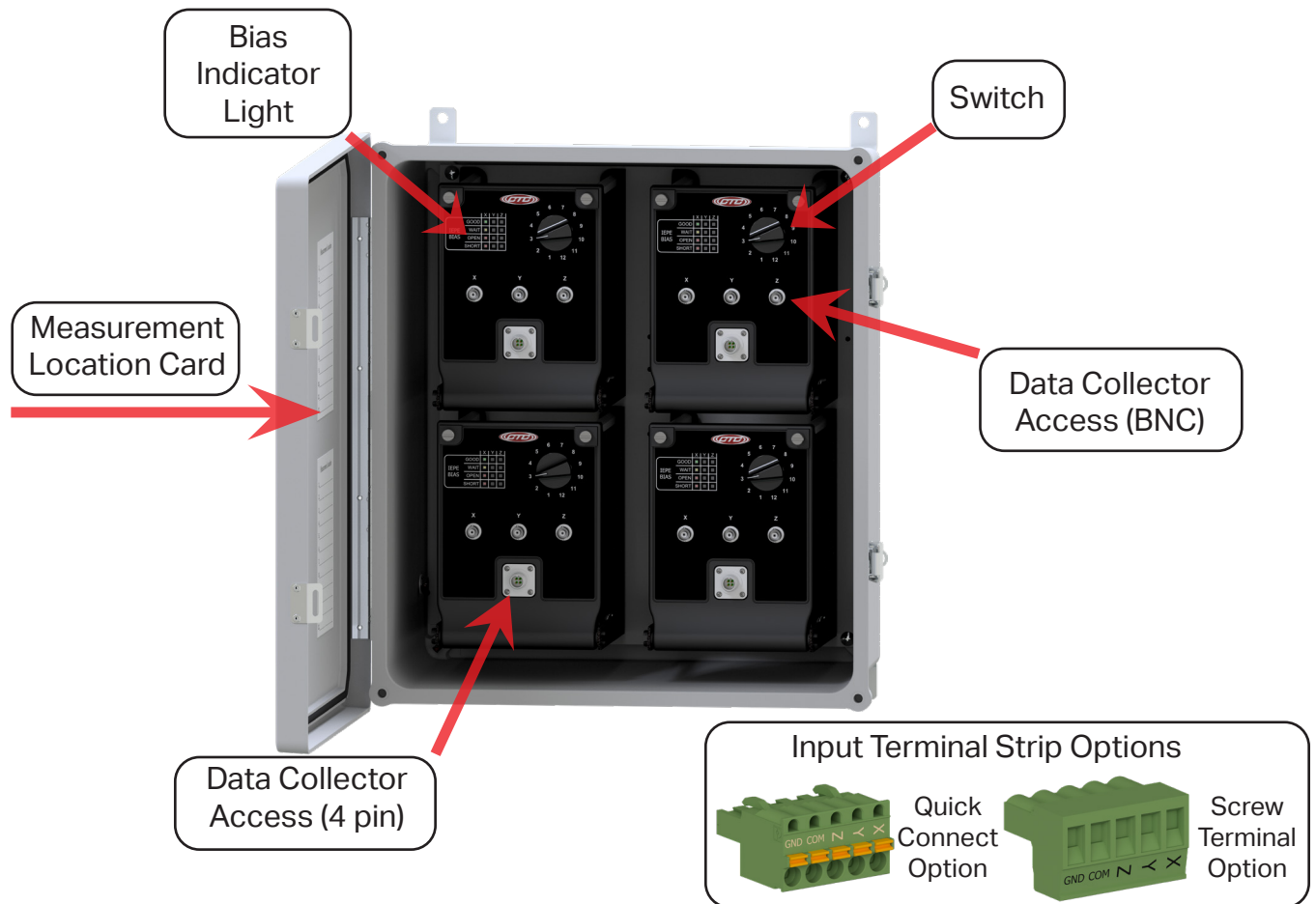

Figure 2. Diagram



MOUNTING INSTRUCTIONS

Note: If you have purchased a switch box without cable entries provided, you should add your own entry prior to mounting the modular switch box. CTC does not recommend drilling holes in the top of the enclosure due to access and moisture concerns.

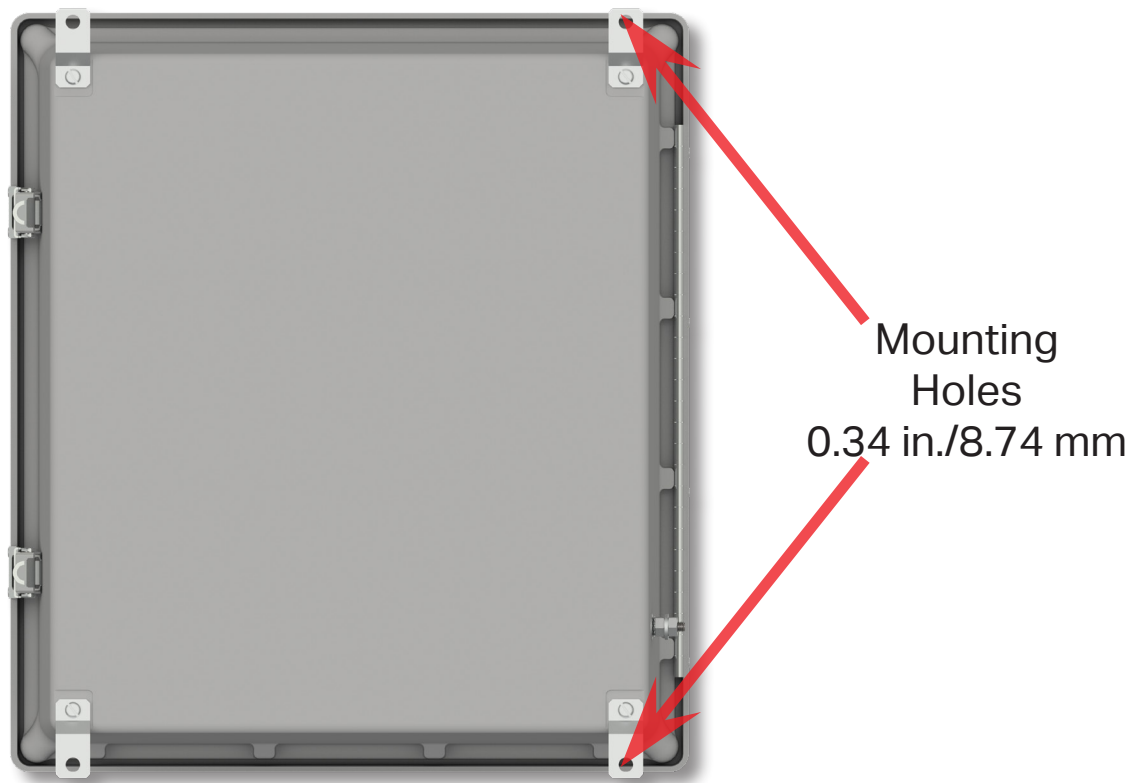

Figure 3. Expanded Capacity Switch Box Rear View

CONDUIT ENTRY

If you have purchased a switch box without cable entries provided, you should add your own entry prior to mounting the enclosure. CTC does not recommend putting holes in the top of enclosures as it will cause restricted access to the wire termination connection points and also allow possible moisture ingress.

Note: To prevent a buildup of condensation inside the enclosure, provide drainage by drilling a hole in the lowest point of the conduit.

Correct



Drill Drain
Hole Here

Incorrect

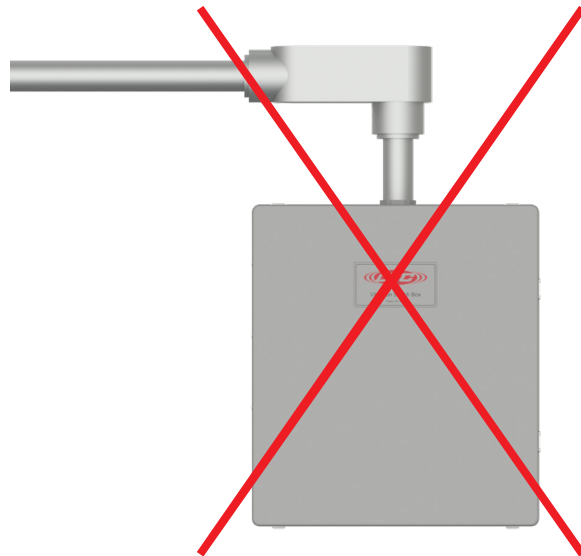

Figure 4. Conduit Entry for Switch Box

GROUNDING

Ensure the shield ground wire on the JB130 Series Switch Box is grounded to earth ground.

A. Mounting to Earth Ground

When mounting JB130 Series Switch boxes to earth ground (such as an I-Beam), mount the shield ground wire using a mounting bolt through one of the mounting brackets on the enclosure. See Figure 5 below.



Figure 5. Proper Shield Grounding Technique

GROUNDING

B. Mounting to Non-Grounded Structure

When mounting the switch box to a non-grounded structure, ensure the shield ground wire or customer-supplied ground wire is tied to a source of earth ground.

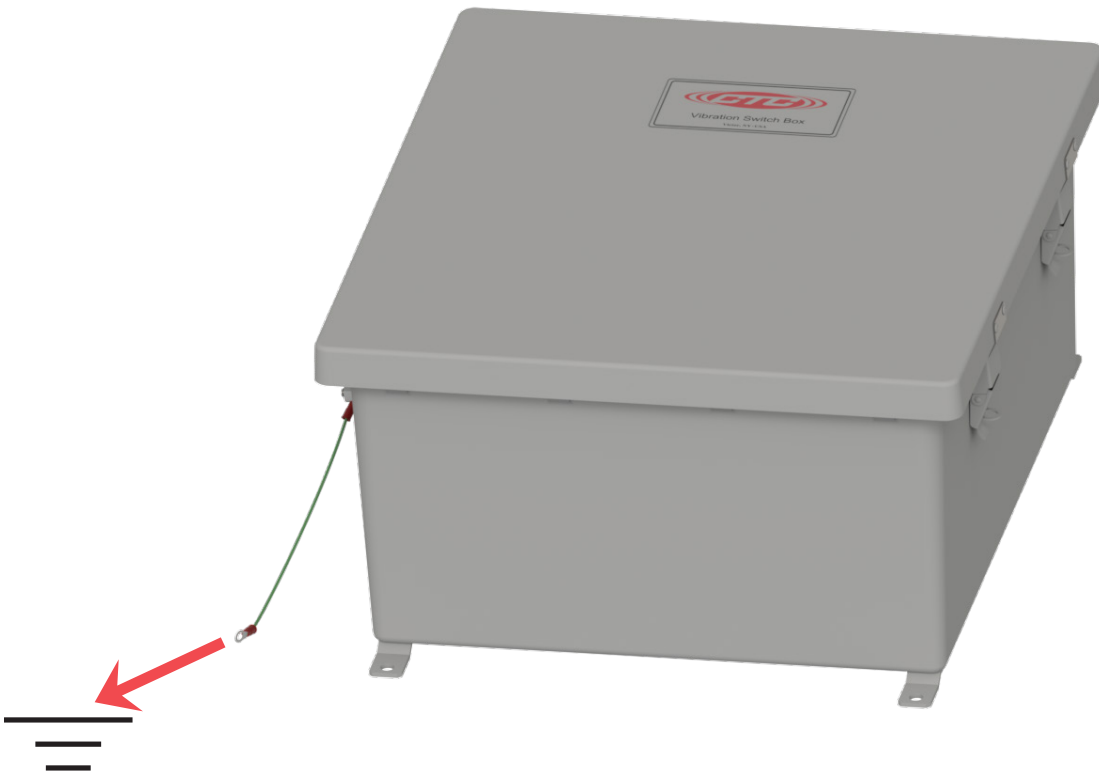

Figure 6. Ground Wire Placement

SENSOR INSTALLATION

Installation of Sensors/Signal Input Cable

1. Feed blunt-cut end through the cable entry at the bottom of the enclosure.
Note: It is recommended that cables are marked on both ends.

For cord grip cable entry, take off the cord grip cover with bushing and run cable through it then into the enclosure. Hand-tighten cord grip cover to base to prevent damage of cord grip.

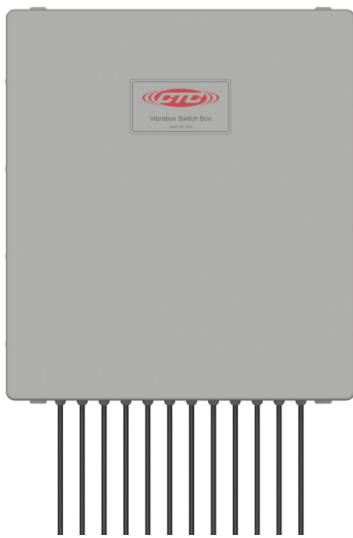

Figure 7. Front View

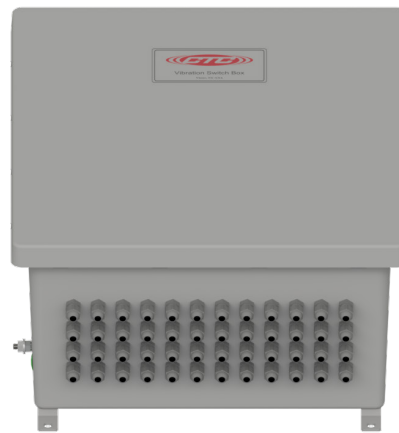

Figure 8. Bottom View with Cord Grips Installed

1. Strip outer jacket of cable back 1¼ in. and remove all of the shielding.
2. Separate the internal wires from the shield.
3. Strip red and black insulation back ¼ in.

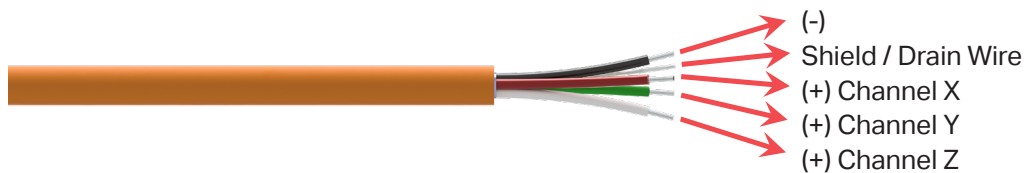

Figure 9. Stripped Wire

SENSOR INSTALLATION

4. Locate the appropriate plug (identified by channel number), remove it, and install the wires using a small flathead screwdriver. Push plug back into location. Orientation is as follows:
 - a. Green insulated conductor wire is connected to Channel X.
 - b. Red insulated conductor wire is connected to Channel Y.
 - c. White insulated conductor wire is connected to Channel Z.
 - d. Black insulated conductor wire is connected to (-).
 - e. Shield drain wire is connected to ground (GND).

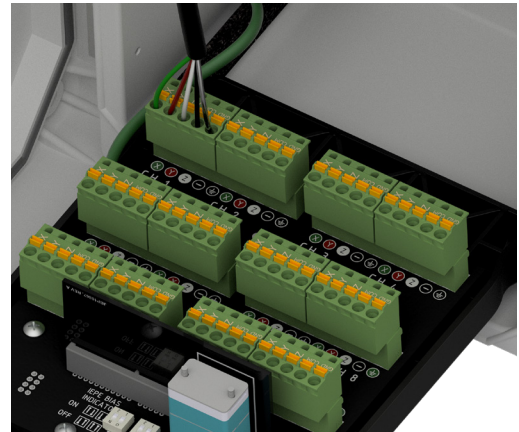
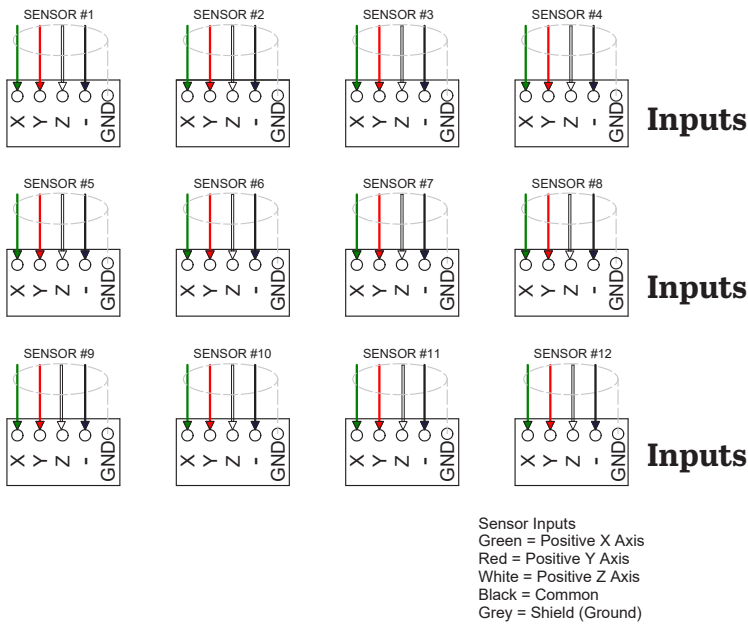

Figure 10. Field Wiring for Four-Conductor Triaxial Sensor Inputs

SENSOR INSTALLATION

5. Insert plug into the appropriate PC board connector and double check to ensure that the cable is going to the correct channel.

Note: If your application requires continuous output, the wiring configuration for the JB130 is slightly modified.

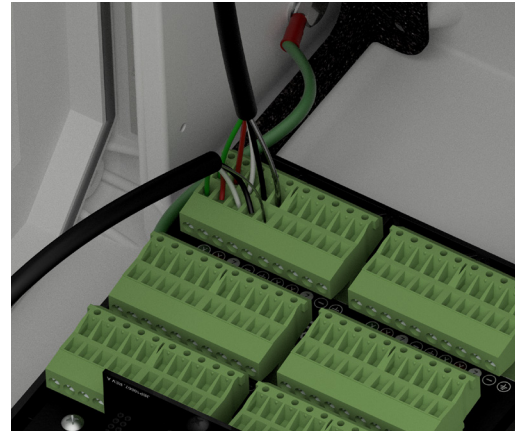
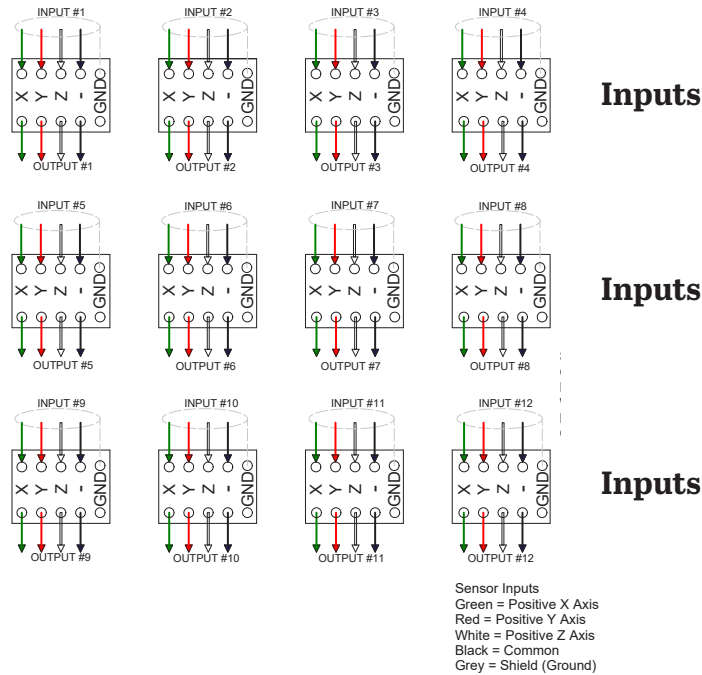

Figure 11. Field Wiring for Continuous Output

6. Mark the Measurement Location Card located on the inside front cover with a description of each measurement location.

POST-INSTALLATION TESTING

The TM1018 Accelerometer Verification Meter can be used to verify cable conductivity, sensor location and proper wiring connections. The Verification Meter will indicate if the sensor, cable and/or junction box is in working condition. It will also confirm bias voltage of the accelerometer, which will inform you of the operation of the internal accelerometer amplifier.

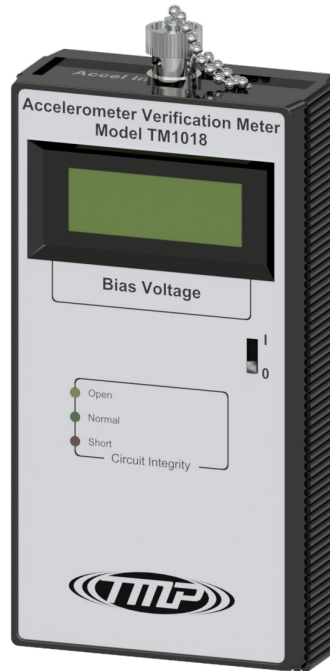

Figure 12. TM1018 Accelerometer Verification Meter

Testing Method:

1. Utilizing two personnel, Person A will be located at the switch box, while Person B will be located at the measurement location.
2. Once positioned, Person A will connect the TM1018 to the data collector output on the switch box and turn the Channel Selector to the channel that corresponds to the referenced measurement. Person A should observe a "NORMAL" LED reading.
3. Person B disconnects the cable from the accelerometer, and the TM1018 should respond with an "OPEN" LED. Reconnect the cable to the accelerometer, and the TM1018 should respond with a "NORMAL" LED.
4. Repeat for each measurement location to verify that accelerometer location is properly identified at the switch box.

POST-INSTALLATION TESTING

The following LED Readout indicates the circuit integrity:

1. Green LED: Normal. Indicates proper connection and an output bias will be given, indicating the health of the sensor (4 – 16 V indicates a healthy accelerometer).
2. Yellow LED: Open Circuit. Indicates one of the following:
 - a. Cable connector is not connected to accelerometer.
 - b. Cable is open circuit (broken or not connected at one end).
 - c. Accelerometer is not functioning correctly.
3. Red LED: Short Circuit. Indicates one of the following:
 - a. Water or contamination in the connector.
 - b. Reverse wiring ((+) and (-) leads are reversed) at terminal block inputs of the switch box.
 - c. Wires in switch box or cable connector (+) & (-) are touching.

MAINTENANCE

Once the system has been installed, it requires minimal maintenance. Basic checks to ensure system integrity should be made periodically.

Visual inspection should include examinations for the following:

1. No visible electrical burns or smoke inside the enclosure.
2. Enclosure hinges are free from rust and securely latched.
3. No moisture or condensation is present inside the enclosure.



WARRANTY & REFUND

Warranty

All CTC products are backed by our unconditional lifetime warranty. If any CTC product should ever fail, we will repair or replace it at no charge.

Refund

All stock products can be returned for a 25% restocking fee if returned in new condition within 90 days of shipment. Stock products qualify for free cancellation if your order is cancelled within 24 hours of purchase. Built-to-order products qualify for a 50% refund if returned in new condition within 90 days of shipment. Custom products are quoted and built specifically to the requirements of the customer, which may include completely custom product designs or private labeled versions of standard products for OEM customers. Custom products ordered are non-cancellable, non-returnable and non-refundable.

