



PROTECTION & RELIABILITY INSTRUMENTS



**PXE250 Series Proximity Probe Driver Enclosure
6 Channel
Product Manual**

TABLE OF CONTENTS

• Introduction	3
• Product Description	3
• Product Dimensions	4
• Mounting Instructions	5
• Conduit Entry	6
• Grounding	7
• Electrical Connections	8
• Proximity Probe Connection.....	11
• Operation	12
• Post Installation Testing	13
• Warranty & Refund	14



INTRODUCTION

PRO Proximity Probe Enclosures feature Din Rail mounting for factory installed probe drivers.

The PXE250 Series stainless steel enclosure protects up to 6 proximity probe drivers from dirt, dust, oil, and water. Outputs from the driver are available via screw terminals on the driver and/or BNC connectors. Loop power output options are also available. Drivers are din rail mounted in the enclosure. Connection to the probe is established when a proximity probe and its extension cable are connected to the gold SecureLock connector on the driver. Excess proximity probe cables should be coiled up inside the enclosure.

Rated for NEMA 4X (IP66), the PXE250 can withstand harsh environments including temperatures ranging from -58 to 180 °F (-50 to 82 °C). The box is also resistant to hose directed fluid and corrosion. A locking latch is installed on the door allowing the box to be sealed from the elements when not in use.



PRODUCT DIMENSIONS

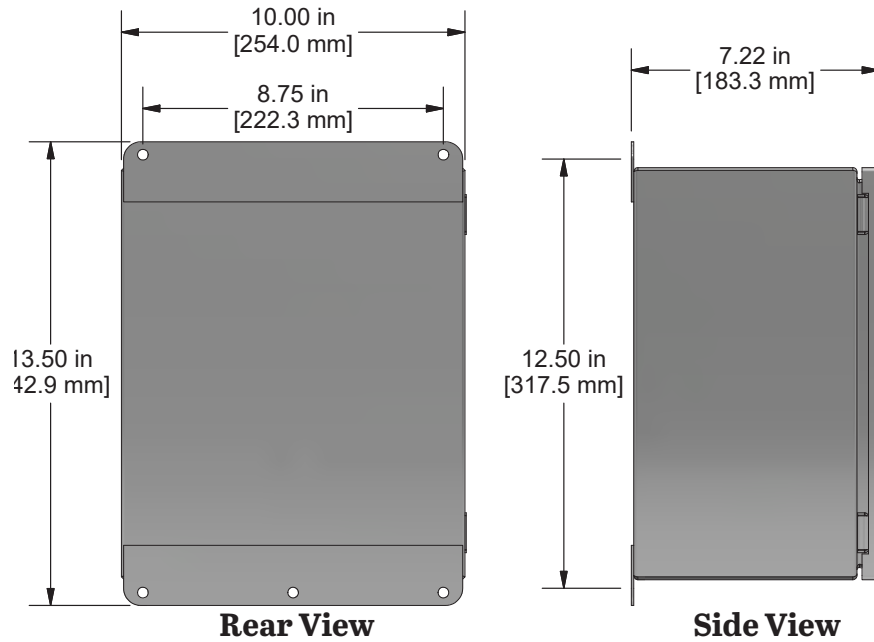

Figure 1. Dimensions

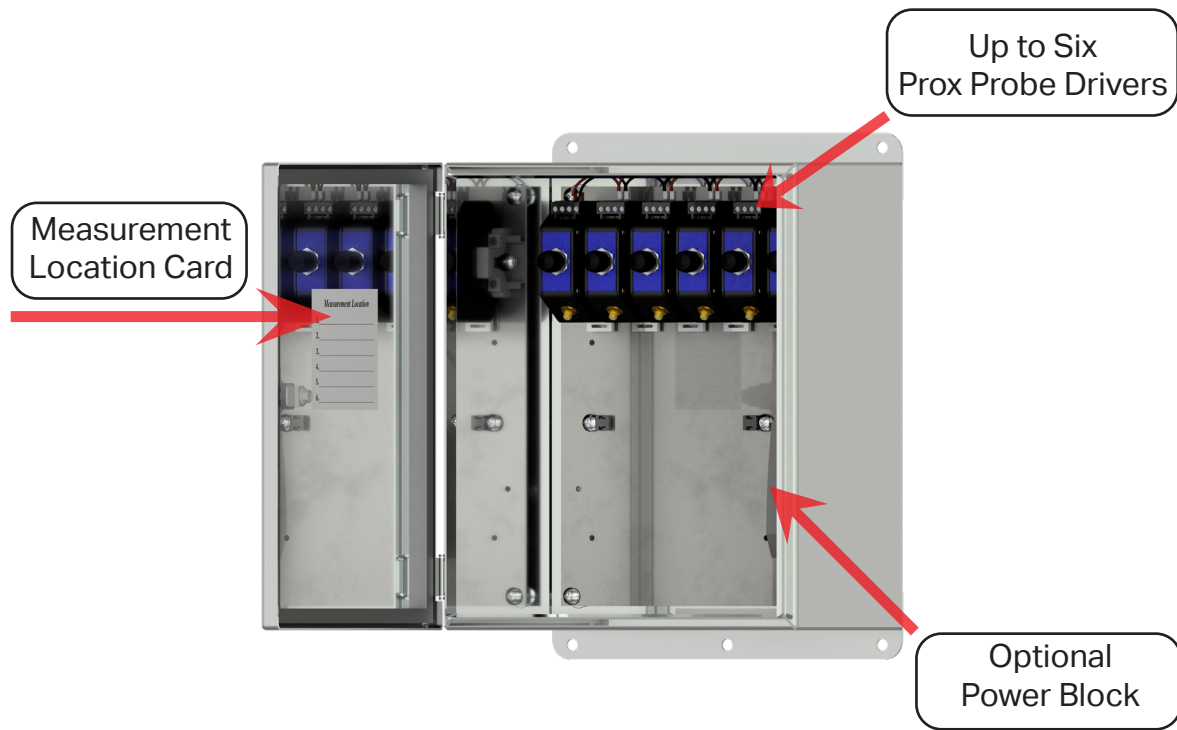

Figure 2. Diagram

MOUNTING INSTRUCTIONS

Stainless steel mounting brackets are included on the enclosure. Wall anchoring screws are not included.

Note: If you have purchased an enclosure without cable entries provided, you should add your own entry prior to mounting the enclosure. CTC does not recommend putting holes in the top of the enclosure due to access and moisture concerns.

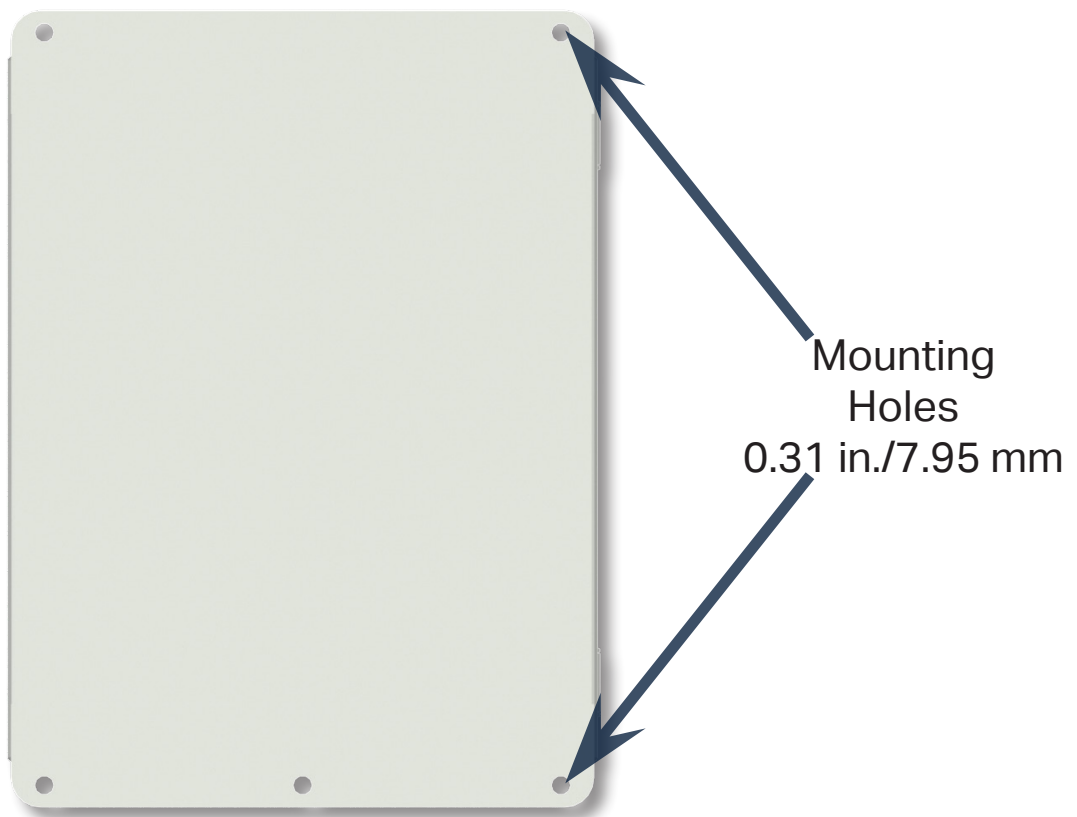

Figure 3. Mounting Bracket Placement

CONDUIT ENTRY

If you are running conduit to your enclosure, ensure the conduit cable entry enters from the bottom of the enclosure when mounted.

Note: To ensure moisture will not flow into the enclosure, a hole should be drilled at the lowest point in the conduit to provide drainage for any moisture.

Correct

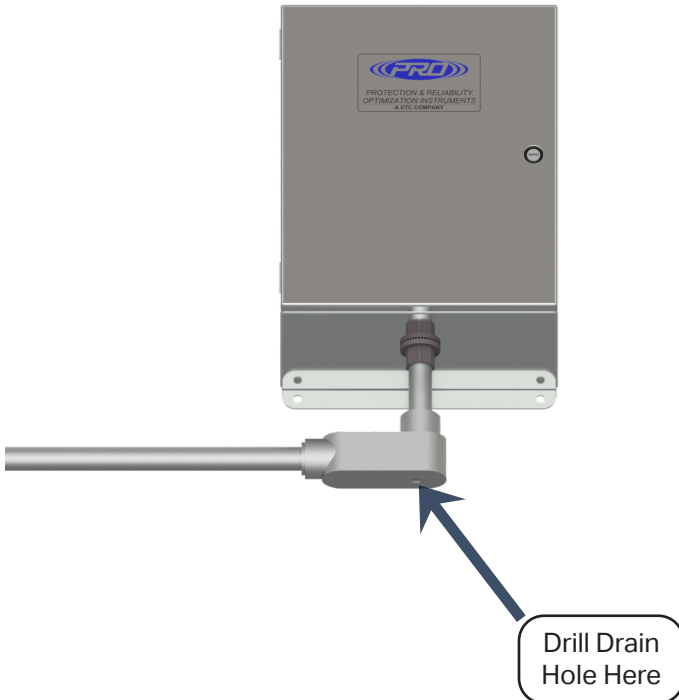

Incorrect

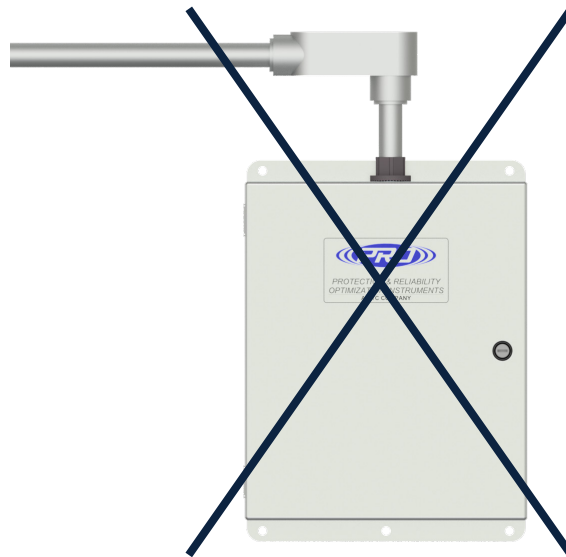

Figure 4. Conduit Entry for Proximity Probe Driver Enclosure

GROUNDING

Ensure the shield ground wire on the PXE250 Series enclosure is grounded to earth ground.

A. Mounting to Earth Ground

When mounting PXE250 Series boxes to earth ground (such as an I-Beam), no additional steps are necessary, as the enclosure is grounded internally.



Figure 5. Proper Shield Grounding Technique

B. Mounting to non-grounded structure

When mounting the enclosure to a non-grounded structure, ensure the shield ground wire or customer supplied ground wire is tied to a source of earth ground.

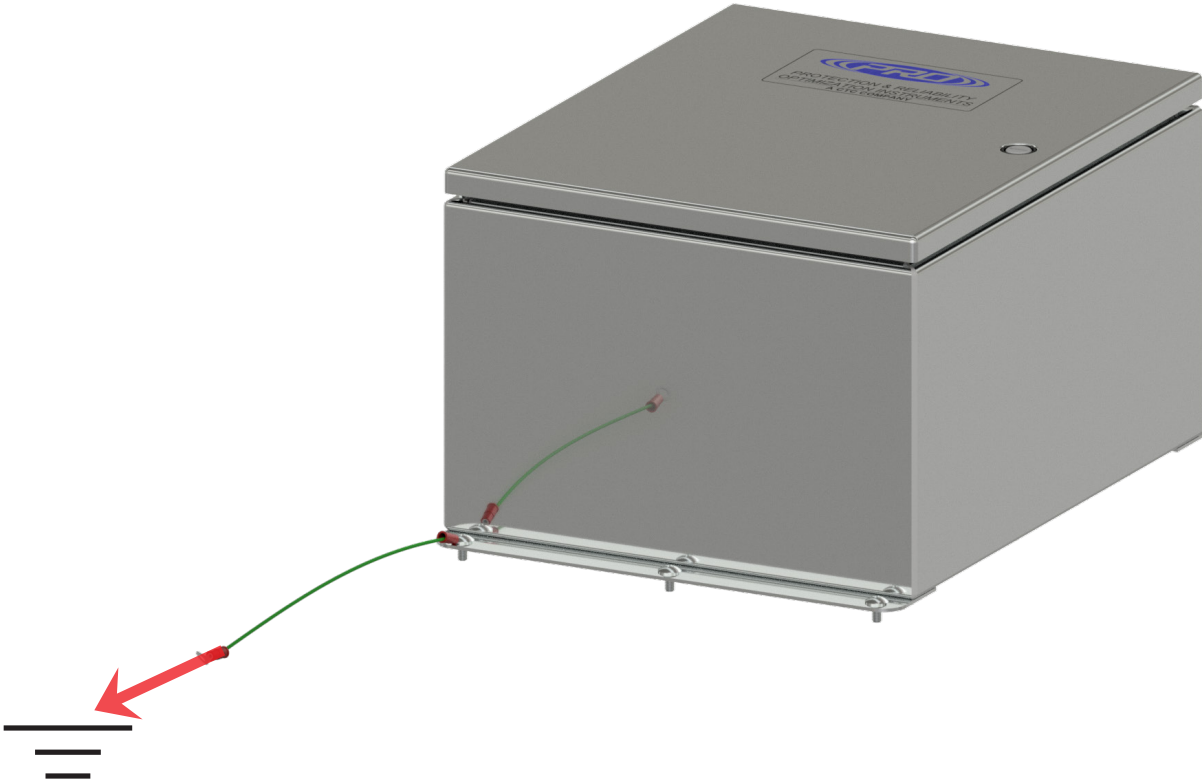

Figure 6. Ground Wire Placement

ELECTRICAL CONNECTIONS

Inputs

Cables enter the enclosure through the designated entry option. All wires are connected to probe drivers within the enclosure via SecureLock vibration resistant locking connectors.



Figure 7. Cable Entry

Outputs

Cables exit the enclosure through the designated exit option selected. All wires are connected to probe drivers within the enclosure.



Figure 7. Cable Exit

CTC will preinstall any proximity probe drivers (sold separately) that are purchased alongside the PXE250. Power for the drivers is wired in parallel, through the COM and Vt inputs on the driver. The drivers will require a power source within the range of 17½ - 30 Vdc, while 24 V is considered optimal for achieving the full measurement range of the proximity probe. An optional internal power supply can be purchased by selecting the PXE250-P variant when ordering. For more information on power requirements, refer to the product manual included with the purchased drivers.

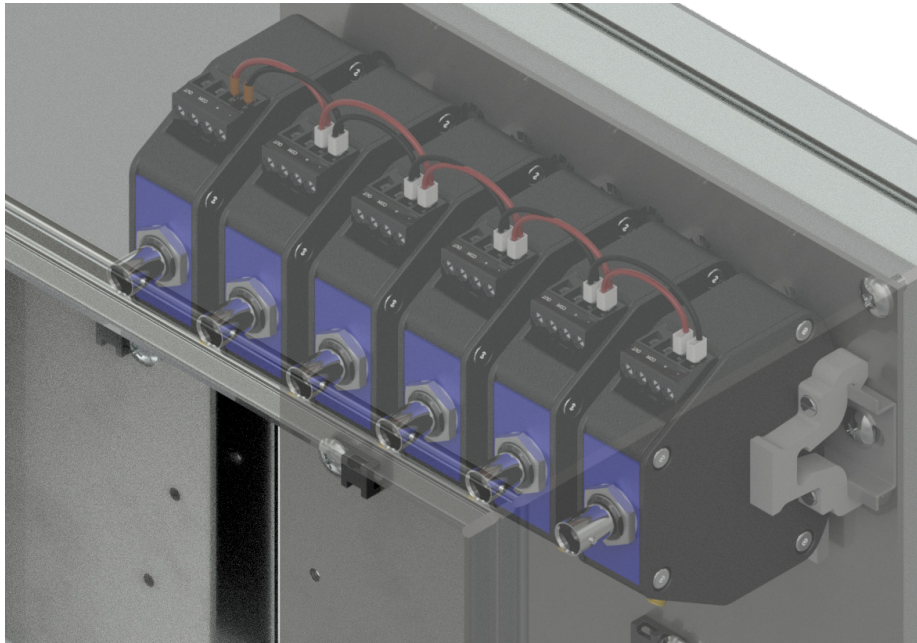
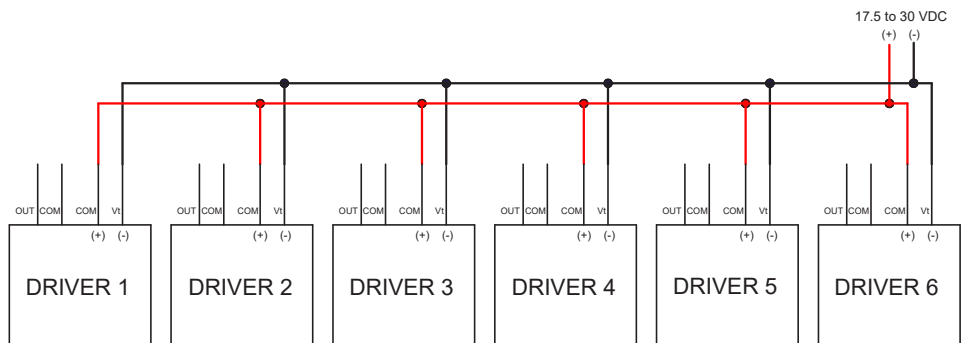

Figure 10. Power Routing for Probe Drivers

PROXIMITY PROBE CONNECTION

Refer to the manual included with any purchased probe drivers for proper connection of the proximity probe to the driver. Be sure to tighten the connection by hand, without the use of tools. You will hear or feel a click when the anti-vibration locking mechanism engages. Continue to tighten until you hear or feel 2-3 clicks.

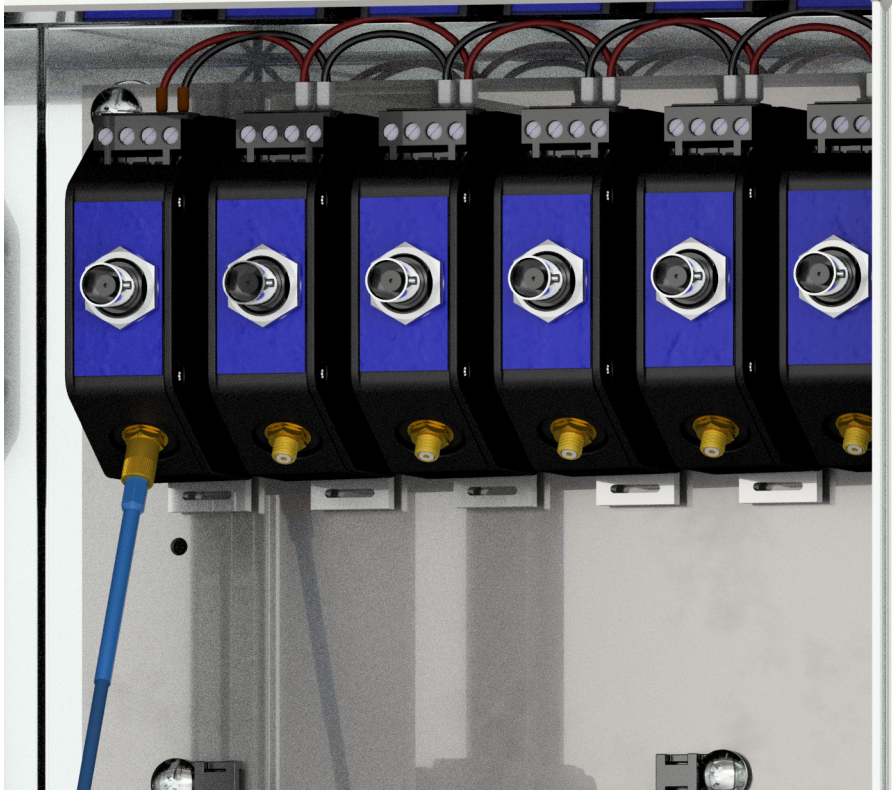

Figure 11. Connecting Proximity Probes

PORTABLE DATA COLLECTOR INTERFACING

To collect waveform data from the BNC jack on the proximity probe driver using a portable data collector, **ensure that the data collector does not have power enabled on the port you're using** (such as IEPE or constant current source). Failure to do so may result in a damaged or non-functional transmitter.

When all connections to the driver have been made, and the probe is in place, apply power to the system. For applications where the only data of interest is vibration level and measuring the gap is not important, the voltage at the OUT (signal output) terminal should be compared relative to the voltage at the COM (common) terminal. Refer to the table below for the appropriate difference (± 0.5 volts) for each length of PRO proximity probe. Adjust the probe gap until this reading is obtained.

Probe Length	Voltage at BNC (V_{OUT})	Rough Distance
FFV	7.5 V	40 mils
8 mm	9 V	50 mils
11 mm	9 V	100 mils
25 mm	7 V	275 mils

Figure 12. Determining Probe Gap Distance

For applications where the actual gap needs to be measured, adjust the probe until a reading is obtained that reflects the desired initial gap setting

POST INSTALLATION TESTING

To test if individual proximity drivers are working while powered, the voltage can be read out of either the OUT and COM terminals or out of the BNC jack. This can be done with a DC voltage meter or data collector (ensure collector is NOT setup to supply sensor power.) Refer to the table below for help interpreting the voltage output you receive.

Problem	Recommended Action
-0.5 to -0.6 VDC Signal Output	Check Probe Cable / Extension Cable Connection
No Signal Output	Check Power Supply
Adjusting gap for one probe affects reading on another	Check all wiring to the OUT terminals and BNC, they should not be shared between drivers.

Figure 13. Results of a Voltage Output Reading

WARRANTY & REFUND

Warranty

All PRO products are backed by a lifetime warranty on materials and workmanship. PRO will repair or replace any of our products as long as the product was not subjected to misuse, neglect, natural disasters, improper installation, or modification.

Refund

All stock products qualify for a full refund if returned in new condition within 90 days of shipment. Build to order products qualify for a 50% refund if returned in new condition within 90 days of shipment. Custom products are quoted and built specifically to the requirements of the customer, which may include completely custom product designs or private labeled versions of standard products for OEM customers. Custom products ordered are non-cancellable, non-returnable and non-refundable.

