



CONNECTION TECHNOLOGY CENTER, INC.

LEVEL 2 – LESSON 1

BASICS OF ACCELEROMETER MOUNTING AND INSTALLATION



INTRODUCTION

Welcome to **Level 2, Lesson 1** of CTC's free online vibration analysis training. We hope you enjoyed and benefited from the previous Level 1 Introduction course, and will continue to build your vibration analysis knowledge as you progress through Level 2.

'Basics of Accelerometer Mounting and Installation' is created and presented by CTC for complimentary educational use only. This training presentation may not be edited or used for any other purposes without express written consent from CTC.



MOUNTING - OBJECTIVES

By the end of this lesson, you will understand the advantages and disadvantages inherent in the various mounting methods for your accelerometer or Piezo Velocity sensor.

By better understanding these basic principles, you will be better able to decide which hardware and technique to utilize based on the type of data you require for a given application.

We will review the following installation techniques:

STUD MOUNT
ADHESIVE MOUNT
PORTABLE MOUNT





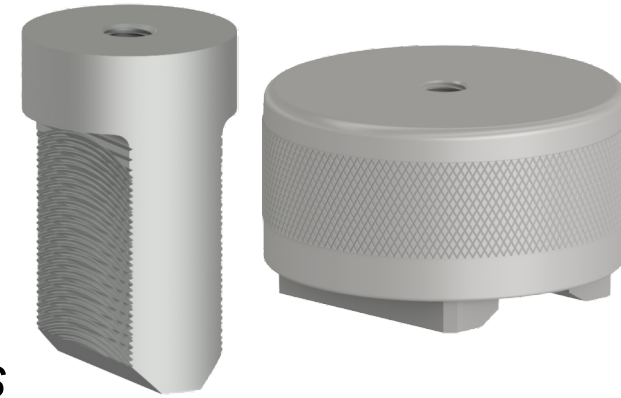

MOUNTING – 4 MOUNTING STYLES

There are 4 general categories of mounting styles which we will focus on:

- ❑ **MAGNET MOUNT** *with a curved-surface magnet*
- ❑ **SPECIALTY MOUNTING PADS** *such as motor fin mount pads*
- ❑ **EPOXY PADS** *including quick connect studs, targets for flat magnets, and permanent mounting studs*
- ❑ **STUD MOUNT**

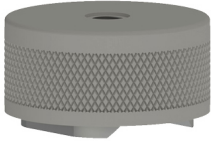
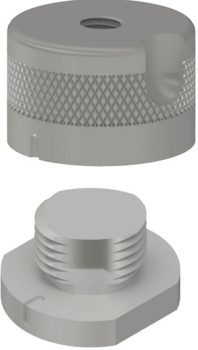

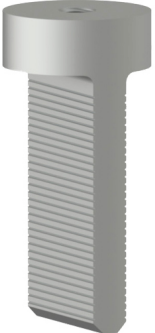
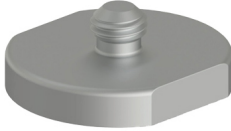
MOUNTING – ADVANTAGES AND LIMITATIONS

	PORTABLE MEASUREMENT			PORTABLE OR PERMANENT		PERMANENT MOUNT	
MOUNTING METHOD	 CURVED SURFACE MAGNET	 QUICK CONNECT	 FLAT MAGNET WITH TARGET	 GREASE MOUNT	 FIN MOUNT PAD	 ADHESIVE MOUNTING PAD	 STUD MOUNT
FREQUENCY RESPONSE	<p>There are advantages and disadvantages to each method of sensor mounting. Generally speaking, an analyst will capture better data when the mounting method adds minimal 'mass' (or weight), maximizes surface area contact, maximizes 'stiffness' (how firmly the sensor is attached to machinery), and is located closer to the source of the vibration.</p> <p>The following few slides will use a 'fair to best' rating system to compare some of the more desirable mounting methods:</p>						
EASE OF INSTALLATION							
REPEATABLE DATA							

★ = FAIR



★★ = GOOD

★★★ = BETTER

★★★★ = BEST

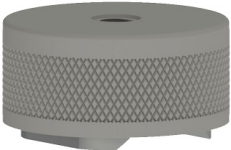
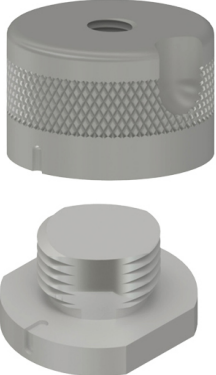

PORTABLE MOUNTING – ADVANTAGES AND LIMITATIONS

	PORTABLE MEASUREMENT		
MOUNTING METHOD	 CURVED SURFACE MAGNET	 QUICK CONNECT	 FLAT MAGNET WITH TARGET
FREQUENCY RESPONSE	★	★★★	★★★★★
EASE OF INSTALLATION	★★★★★	★★★	★★★
REPEATABLE DATA	★	★★★★★	★★★★★

★ = FAIR

★★★ = GOOD

★★★★★ = BETTER

★★★★★ = BEST

The area of a curved surface (or '2-bar') magnet is not as good as a quick connect system or a flat magnet with a target, and its mass tends to be higher; therefore analysts should not depend on data above the 2 kHz (120,000 CPM). A flat magnet on a well-installed target can yield reliable data up to 8 kHz and possible 10 kHz (600,000 CPM)!

Similarly, because the quick connect system and the flat magnet with target system both utilize a component which stays attached to the machinery between route collections, the data is very repeatable: same point, same angle.

Any analyst who has used a curved surface magnet knows that it is among the easiest methods of data collection available.

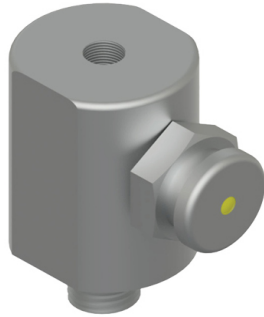
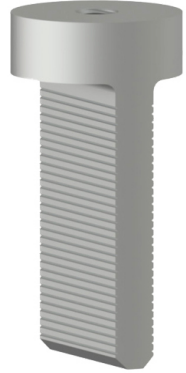

PORTABLE or PERMANENT MOUNTING – ADVANTAGES AND LIMITATIONS

MOUNTING METHOD	PORTABLE OR PERMANENT	
		
FREQUENCY RESPONSE	★ ★	★ ★
EASE OF INSTALLATION	★ ★ ★	★ ★
REPEATABLE DATA	★ ★ ★	★ ★ ★

Specialty mounts, such as grease fitting mounts (also known as Zerk adapters), and motor fin mount pads, tend to add a bit of mass, and lack some stiffness. Regardless, they tend to provide good data – usually in the 2 kHz (120,000 CPM) to 5 kHz (300,000 CPM) range – because they are positioned in good proximity to the source of bearing vibration.

This method also tends to be very repeatable since the accelerometer mounting area on top of the pad will either attract a magnet for repeatable measurements, or will accept a stud for permanent mounting.

Ease of installation varies.

★ = FAIR



★ ★ = GOOD

★ ★ ★ = BETTER

★ ★ ★ ★ = BEST

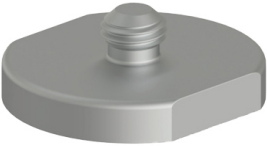

PERMANENT MOUNTING – ADVANTAGES AND LIMITATIONS

	PERMANENT MOUNT	
MOUNTING METHOD	 ADHESIVE MOUNTING PAD	 STUD MOUNT
FREQUENCY RESPONSE	★ ★ ★	★ ★ ★ ★
EASE OF INSTALLATION	★ ★	★
REPEATABLE DATA	★ ★ ★ ★	★ ★ ★ ★

★ = FAIR

★ ★ = GOOD

★ ★ ★ = BETTER

★ ★ ★ ★ = BEST





Assuming proper techniques have been used to mill the surface and affix the sensor, permanent mounting options tend to produce good results at higher frequency ranges (up to the full useful range of the sensor). The data will generally be cleaner, more accurate, and highly repeatable.

To achieve these results, the initial installation requires more care, and more time compared to some portable methods. Permanent mount installations also tend to be more expensive initially, due to dedicating a sensor to each monitoring point. It is worth noting that the additional investment is easily negated when analysts are able to gather better data more efficiently. This will result in making better decisions and less downtime.

All of the methods discussed thus far have their place in a vibration monitoring program. It is up to the analyst to determine the method which is best suited for a given application.

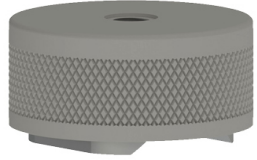
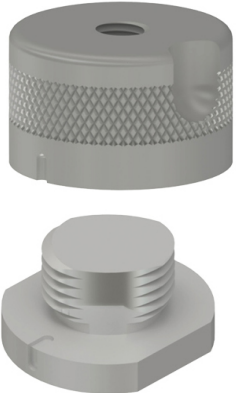

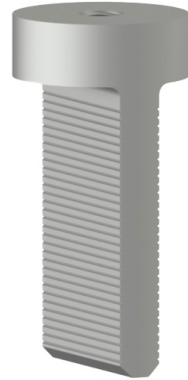
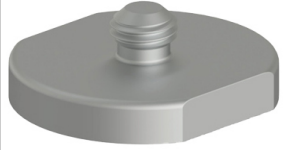
MOUNTING – ADVANTAGES AND LIMITATIONS SUMMARY

	PORTABLE MEASUREMENT			PORTABLE OR PERMANENT		PERMANENT MOUNT	
MOUNTING METHOD	 CURVED SURFACE MAGNET	 QUICK CONNECT	 FLAT MAGNET WITH TARGET	 GREASE MOUNT	 FIN MOUNT PAD	 ADHESIVE MOUNTING PAD	 STUD MOUNT
FREQUENCY RESPONSE	★	★★	★★★	★★	★★	★★★	★★★★
EASE OF INSTALLATION	★★★★	★★	★★	★★★	★★	★★	★
REPEATABLE DATA	★	★★★	★★★	★★★	★★★	★★★★	★★★★

★ = FAIR

★★ = GOOD

★★★ = BETTER

★★★★ = BEST



INSTALLATION AND MOUNTING – TECHNIQUES



After an analyst decides which mounting hardware is best for the particular application, it is important that the proper technique for mounting the sensor and / or pad is used.

Proper technique in mounting the hardware will ensure that the analyst is able to get the most out of the data collected.

Likewise, improper technique in mounting the hardware will result in data which is unclear, or possibly only a partial indication of what is actually happening with the application. Sometimes, improper technique can even damage the sensors or cables, leading to eventual loss of good, consistent data altogether.

The rest of this lesson will focus on the proper techniques for the most common mounting options.

INSTALLATION AND MOUNTING – THINGS TO REMEMBER

Proper permanent installation of mounting hardware or sensors on an application seeks to accomplish several things, including:

- ❑ **Maximizing frequency response and data quality**
- ❑ **Ensuring long-term adhesion**

To maximize frequency response and data quality, an analyst should:

- ❑ **Maximize stiffness**
- ❑ **Limit additional mass**
- ❑ **Maximize surface area contact**
- ❑ **Locate sensors close to the vibration source**

To ensure long-term adhesion, an analyst should:

- ❑ **Use proper surface preparation**
- ❑ **Use materials compatible with the environment in which the application is running**



INSTALLATION AND MOUNTING – INSTALLATION TOOLS

As with most jobs, the right tools will make a difference in the quality of your installations.

Lets take a moment to review the tools you may need:

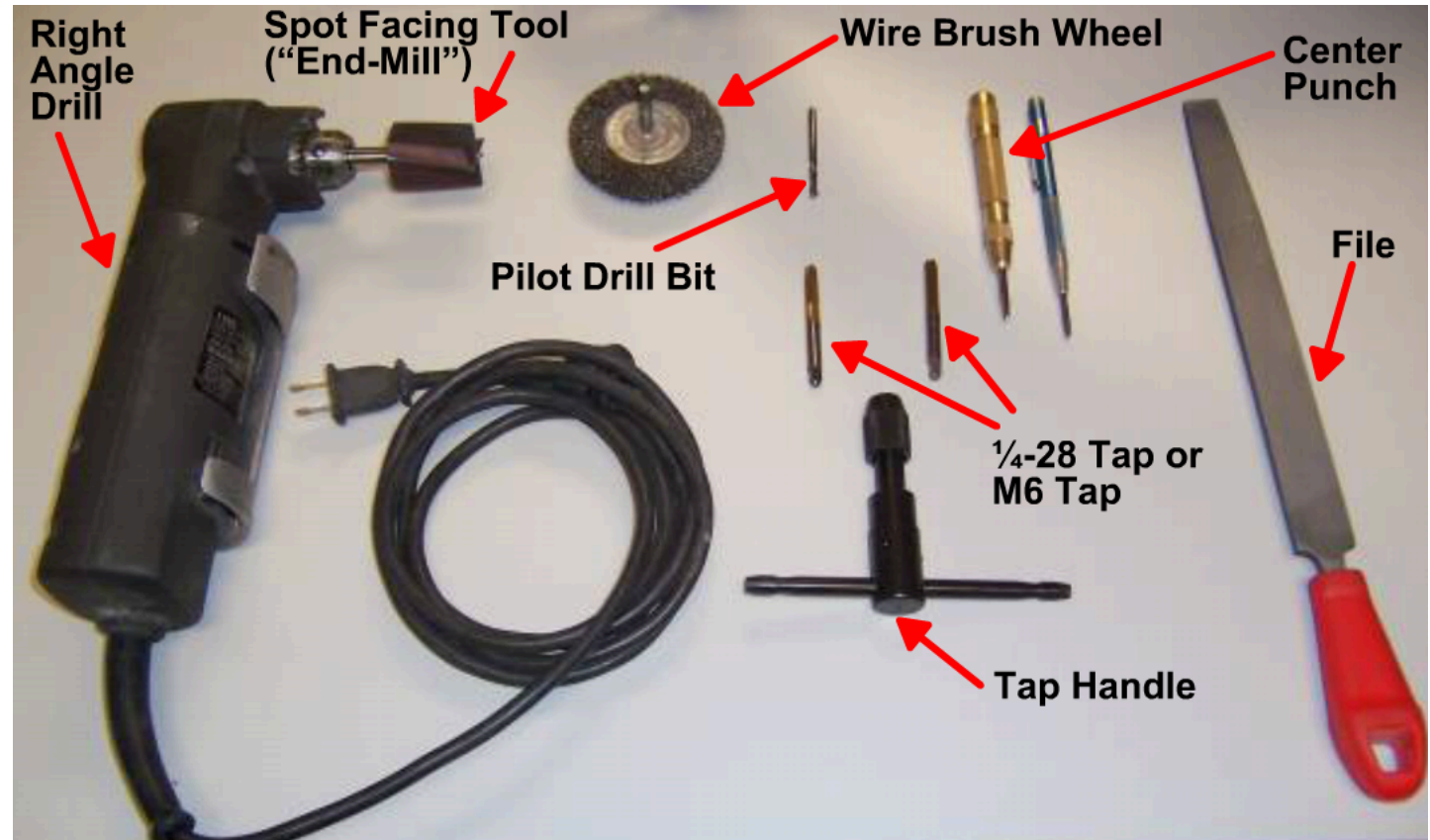

INSTALLATION AND MOUNTING – STUD MOUNTING

Stud mounting your sensors directly to the machinery will provide several advantages:

- ❑ Stud mounting **provides the best transmission of the broadest range of frequencies** (when properly installed), and should allow the analyst to use the full frequency range of the sensor
- ❑ Stud mounting also **provides the most reliable and resilient installation**
- ❑ Stud mounting **meets Intrinsic Safety requirements** since the case of the sensor must be grounded to the machinery when used in an explosive environment (*Note: special sensors and barriers must be utilized in such applications*)

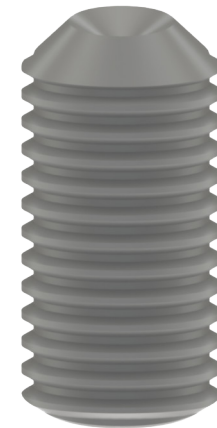
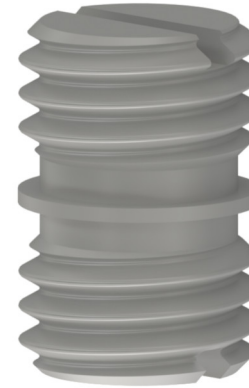

INSTALLATION AND MOUNTING – STUD MOUNTING

Before you begin, consult the engineering drawings of your spec-sheet. Select an end-mill the same diameter as the mounting surface of the sensor. Also note the pilot hole depth and pilot hole diameter that fit the sensor you will be installing.

- ❑ Use a **right angle drill with an end-mill bit** (such as the **MH117 series sensor installation kit**), to create a flat spot on the surface of the machinery
- ❑ **Make sure that the pilot bit in the center of the end-mill is slightly deeper than the exposed length of the stud** you will be using
- ❑ **Apply even pressure** to ensure flatness
 - ❑ Surface finish – 63 or better
 - ❑ Surface flatness - .001 inches
- ❑ **Mill and drill the pilot hole** perpendicular to the surface
- ❑ **Tap pilot hole** with appropriate tap sets
 - ❑ Start tap using the "Starter Tap"
 - ❑ Finish using a "Bottom Tap" which will cut threads all of the way to the bottom of the hole
- ❑ **Clean surface and tighten sensor** into hole roughly 2 to 5 foot pounds (2.7 to 6.8 Nm)
- ❑ **Paint any exposed metal** on the surface to prevent corrosion



ADHESIVE MOUNTING – EPOXY PADS



Epoxy pads are a good solution where a magnet target is desired.

Magnet targets are used to improve the consistency of data being analyzed by ensuring that data is taken from the same point on each 'route' regardless of who is collecting the data.

Targets are also useful for analysts who are using flat magnets to collect higher frequency data. **The polished, flat surface of the target provides better transmission of data over 5 kHz (300,000 CPM).**

Epoxy pads are also frequently used for permanent mounting of sensors where drilling and tapping are not permitted or possible.

Properly installed epoxy pads can transmit high frequency data (10 kHz or 600,000 CPM) very well, and therefore can be used effectively for monitoring many gearbox and bearing faults.

Avoid using them in cooling towers or other aggressive environments that could interfere with the bonding of adhesive.

ADHESIVE MOUNTING – MOUNTING PADS ON MILLED SURFACE

For high frequency response and to limit or eliminate additional peaks, **we suggest spot facing the surface and applying your mounting pads with a thin film adhesive.**

- ❑ Similar to the preparation of a stud mounted sensor, **mill a flat surface the same diameter as the pad** using a right angle drill with end-mill bit, or using a grinding tool
 - ❑ **Use even pressure**
 - ❑ Unlike with the stud mounting preparation, **the pilot drill bit in the end-mill should only be set slightly below the mill** – just enough to catch the surface and prevent the mill from “skating” sideways
- ❑ **Clean the target surface area and that of the pad** with an acceptable, residue-free solution (such as Windex)
 - ❑ Be sure to **wear clean rubber (surgical) gloves** to ensure that the oils and other contaminants from your hands do not contaminate the surfaces you will be cleaning
- ❑ **Apply a thin film of adhesive** (such as Loctite 330) to the pad
 - ❑ **Be sure that the adhesive is compatible with environmental factors** (such as chemicals, moisture, and heat)
 - ❑ Hold pad in place for **30 seconds**, and tape in place for **15 minutes** while adhesive cures
 - ❑ **Touch up with paint** to prevent corrosion



ADHESIVE MOUNTING – MOUNTING PADS ON UN-MILLED SURFACE



Mounting on an un-milled surface will cause a loss of some of the higher frequency signals, however it is sometimes the only choice.

When applying a mounting pad with epoxy, it is important that you **first thoroughly clean the surfaces of the target and the pad**:

- ❑ **Remove paint from area** with end of file or wire wheel to expose bare metal
- ❑ **Properly clean the target surface area and that of the pad** while wearing glove

Since your mounting surface is un-milled, and therefore uneven, **be sure to use a gap filling epoxy, such as Devcon Plastic Welder**.

- ❑ **Mix your epoxy on a clean surface**, or use an applicator 'gun'
- ❑ Make sure that your **adhesive is compatible with environmental factors** (chemicals, moisture, heat, etc).



ADHESIVE MOUNTING – MOUNTING PADS ON UN-MILLED SURFACE

Spread a **thick film of epoxy** on the mounting surface of the pad.

Push the pad onto the mounting surface of your application, and hold in place for 30 seconds to allow epoxy to begin to set. **Do NOT twist the pad**, as this will eliminate much of the epoxy from the mounting surface and adversely effect the adhesion of the pad to the mounting surface.

Tape pad in place while adhesive sets.

Touch up any bare metal with paint to prevent corrosion.

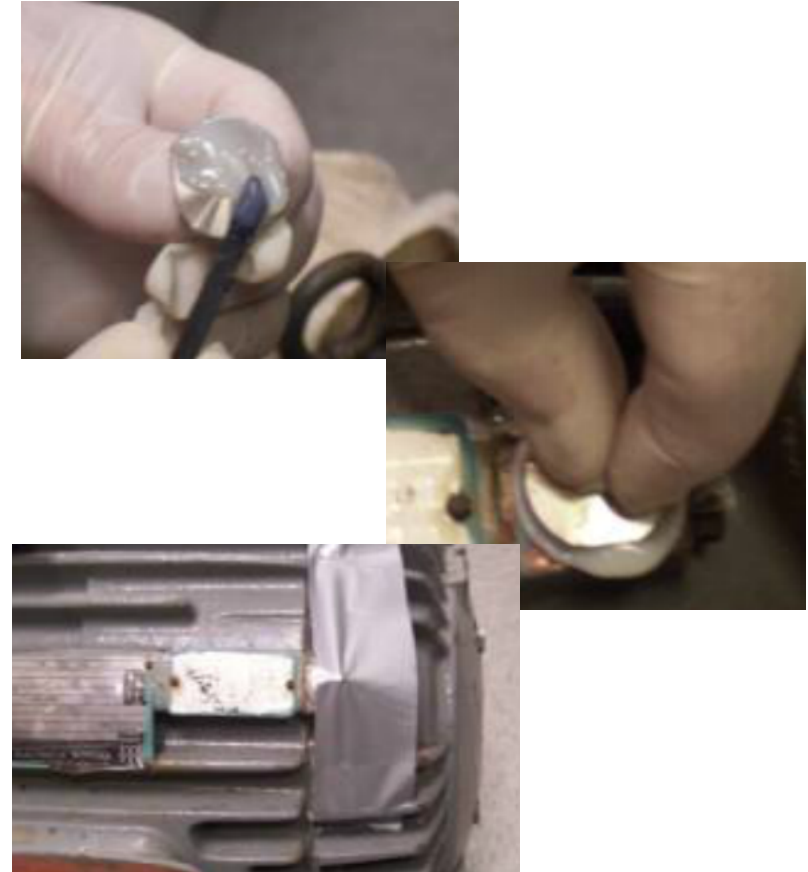

ADHESIVE MOUNTING – INSTALLING MOTOR FIN MOUNTS

To monitor outboard bearings which are covered by an end-bell, analysts should consider using **Motor Fin Mounts**. They will deliver the vibration signal from the bearings through the housing of the motor, avoiding resonant frequencies which would be encountered if collecting data from the end-bell or top of motor fins:

Scrape fins and valley with end of file and / or wire wheel to bear metal; then **clean surface with an acceptable residue-free solution** (such as Windex).

Choose the correct size fin mount so that the bottom of the probe will be seated in the valley of the fin, while the pad remains clear of the top of the motor fin.

While wearing disposable gloves, **apply a generous amount of epoxy to pad**. Be sure to use an epoxy which sets up hard, with good gap filling properties, and fast setting time (such as Devcon Plastic Welder).

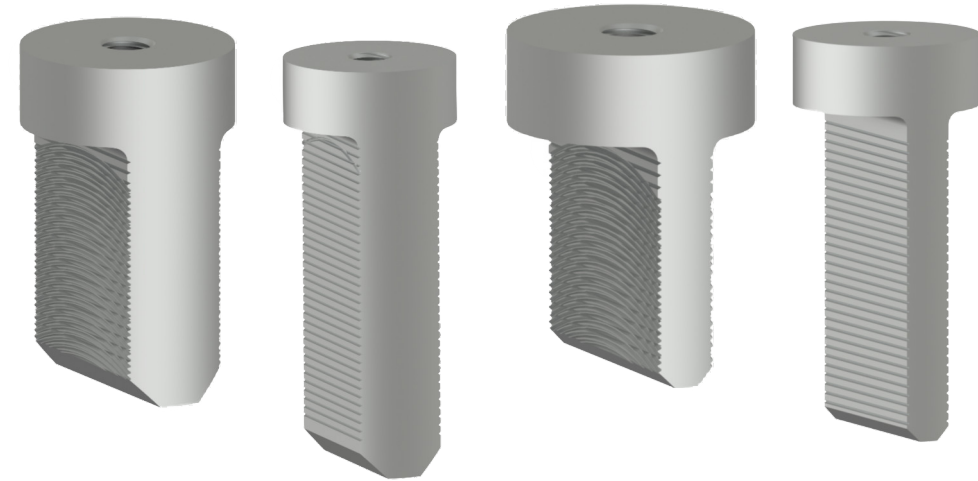

ADHESIVE MOUNTING – INSTALLING MOTOR FIN MOUNTS

Insert the probe portion of the fin mount pad between fins, close to the source of the vibration you are targeting (typically as close to bearing race as possible without touching the end-bell).

Be sure to seat the bottom of the probe in the valley of the motor fin. It is important that the probe base maintains contact with the motor fin valley otherwise you will notice a lack of medium and high frequency data.

Note that the pad section should not touch the top of the fin, otherwise data will include additional resonances from the fins.

Tape the pad in place while epoxy sets.

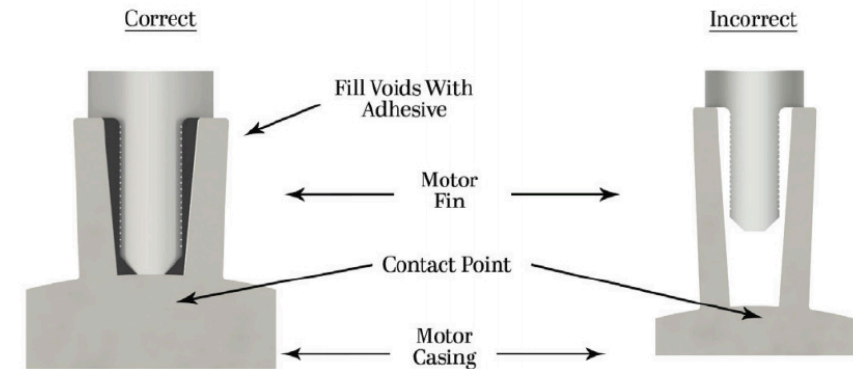

MAGNET MOUNTING – CURVED SURFACE MAGNET MOUNTING

When using a magnet for portable data collection, **the proper technique is to rock the magnet onto, and off of, the mounting surface.**

Failure to rock the sensor onto the surface can produce very high g levels in the sensor. These high g levels can overload the amplifier in the sensor, causing the sensor to overload or saturate, resulting in data which is commonly referred to as a “ski slope.” Ski sloping causes the low frequency data to register such high amplitudes that no other data is visible on the analyzer.

Gently rocking the sensor onto the mounting surface prevents this sudden shock to the sensor and allows the sensor and analyzer to “settle” more quickly, so that accurate data can be obtained.

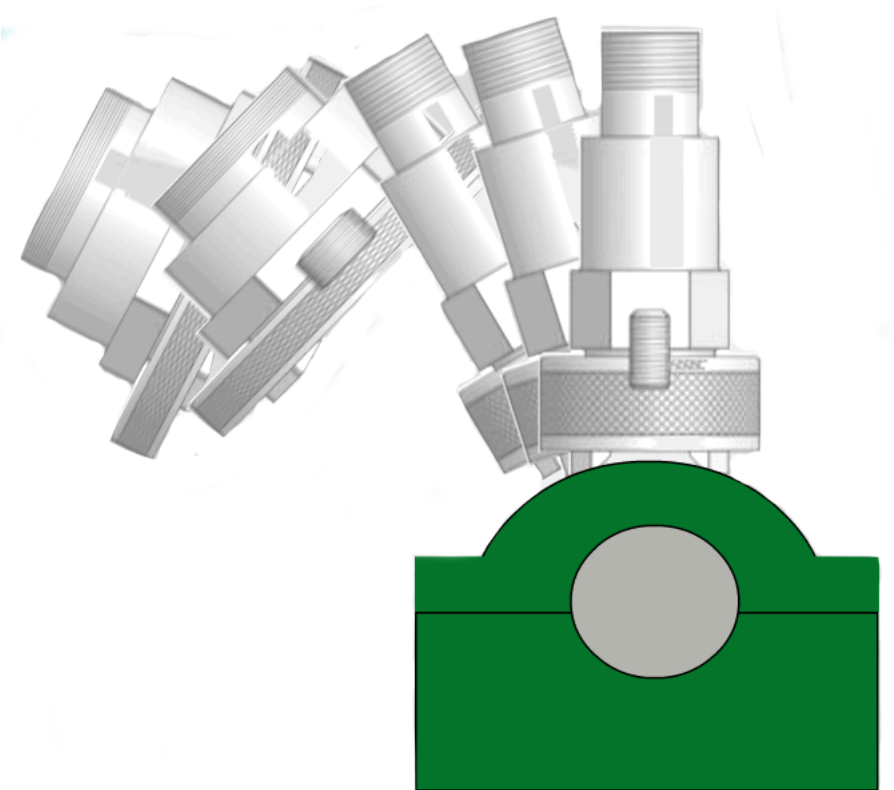

MAGNET MOUNTING – CURVED SURFACE MAGNET MOUNTING

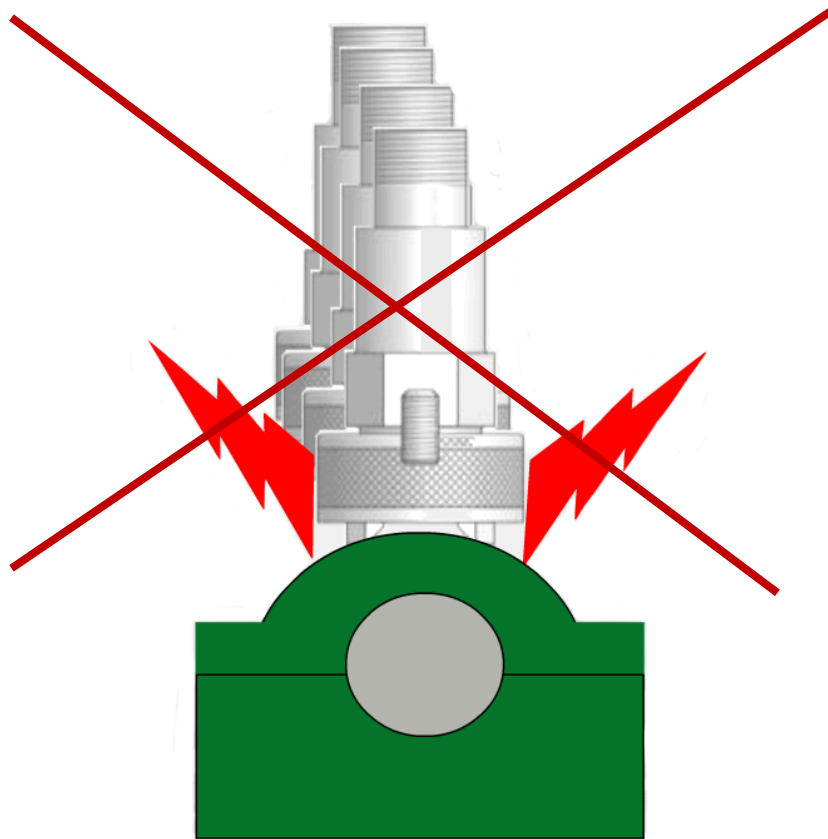

Don't allow your sensor to be slammed onto the mounting surface.

The resulting ski slope or overload condition which may be caused by the shock to the sensor will yield erroneous data, and will prolong your route collection time.

Repeated shock to the sensor could also permanently damage your sensor. Remember that your sensor and data collector are precision tools which must be handled with care to ensure that your data is consistently accurate.

Please take a moment to review the following examples of mounting techniques and positions.



PERMANENT MOUNTING – EXAMPLE 1: MOTOR AND FAN

VERTICAL
HORIZONTAL



VERTICAL
HORIZONTAL

PERMANENT MOUNTING – EXAMPLE 2: FAN

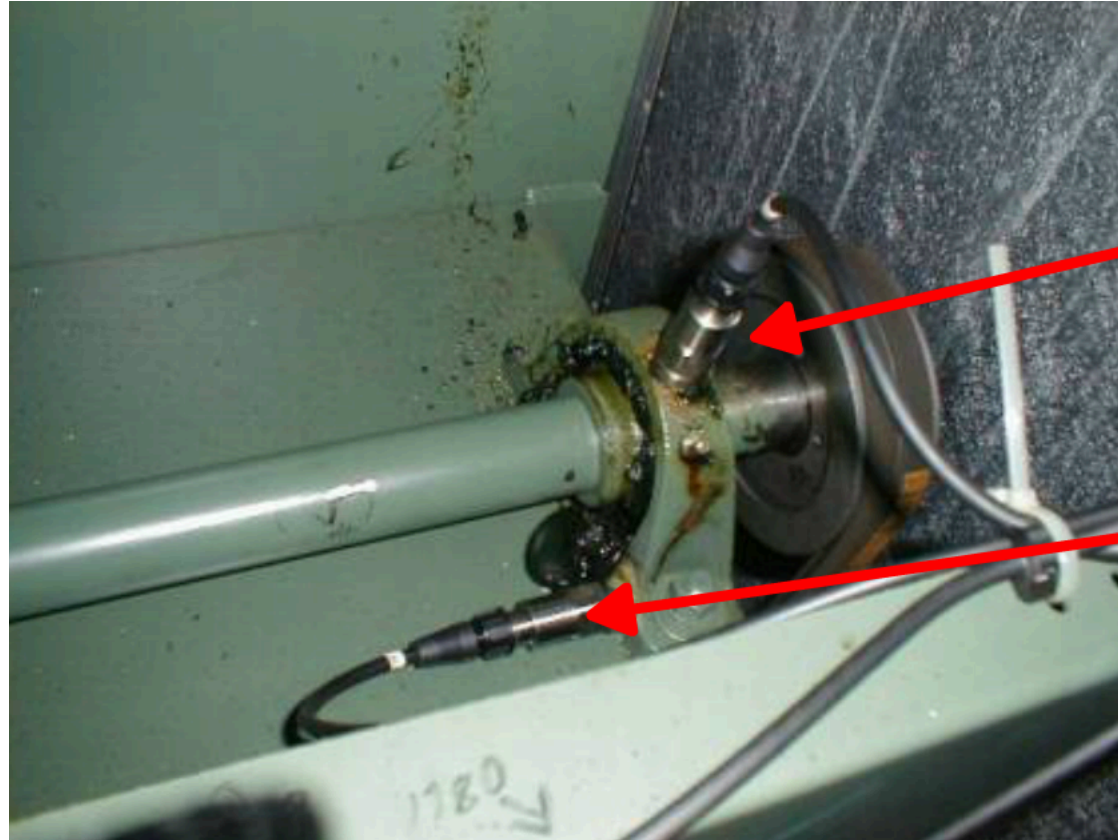

VERTICAL

AXIAL

PERMANENT MOUNTING – EXAMPLE 3: MOTOR

VERTICAL MOUNT
ON A GREASE
FITTING ADAPTER

HORIZONTAL
MOUNT ON A
QUICK CONNECT

AXIAL MOUNT ON
AN EPOXY PAD

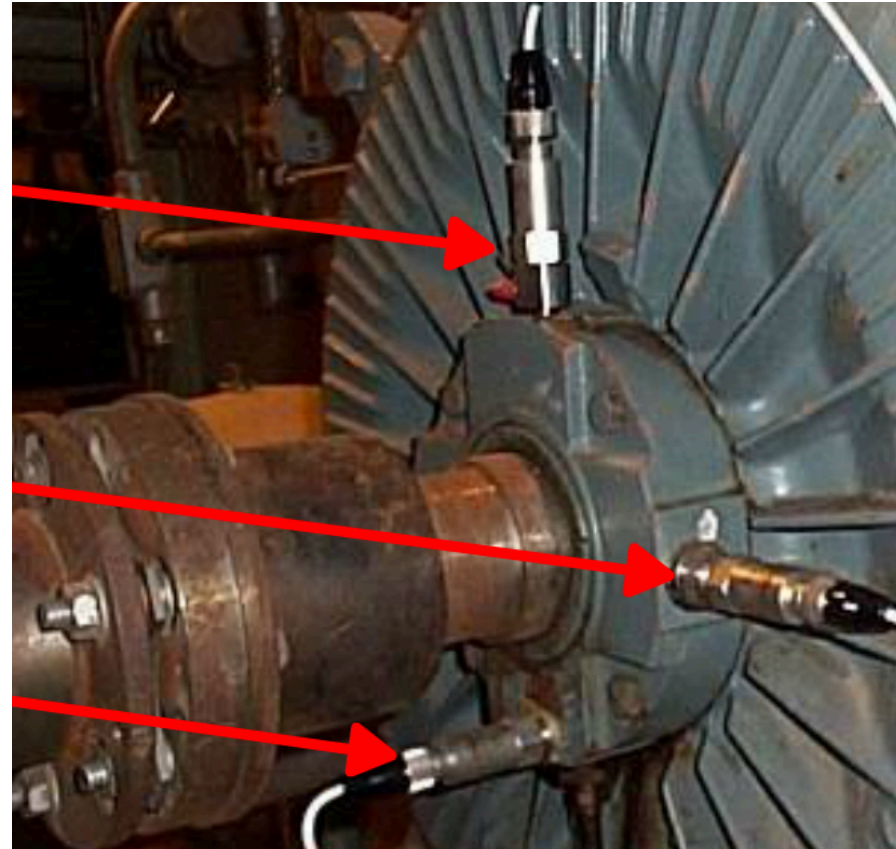

PERMANENT MOUNTING – EXAMPLE 4: COOLING TOWER GEARBOX

AXIAL (OUTPUT)
VERTICAL (INPUT)
HORIZONTAL (INPUT)
AXIAL (INPUT)

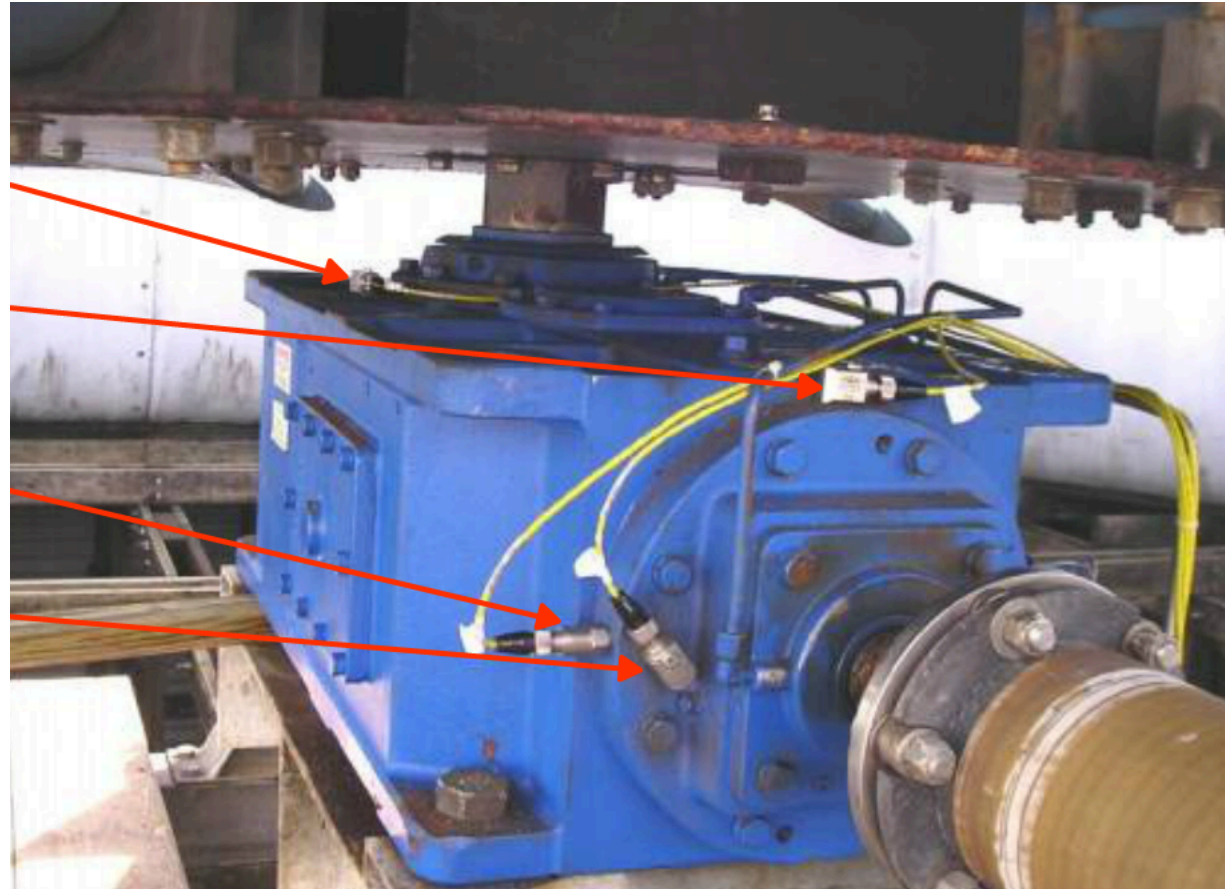

SUMMARY

Thank you for taking the time to review this training lesson. We hope that you learned something that will help you to collect more accurate and quicker data, to allow you to make better "calls."

CTC prides itself on the industry's best customer service and technical support. CTC is proud to employ Vibration Institute Certified Analysts as part of our commitment to providing the industry's best service and support.

For more technical information, additional white papers, and training materials, we invite you to visit our website at www.ctconline.com.



SUMMARY

CTC offers a full range of vibration analysis hardware and process and protection instruments for industrial use. Our customers choose us time and time again based on:

- ❑ **Superior durability**
- ❑ **Accuracy and performance**
- ❑ **Quick service (shipping most orders in 3 days)**
- ❑ **Knowledgeable support staff**
- ❑ **Industry's only UNCONDITIONAL LIFETIME WARRANTY
on all CTC Line products**

CONTACT US AT SALES@CTCONLINE.COM | WWW.CTCONLINE.COM

