

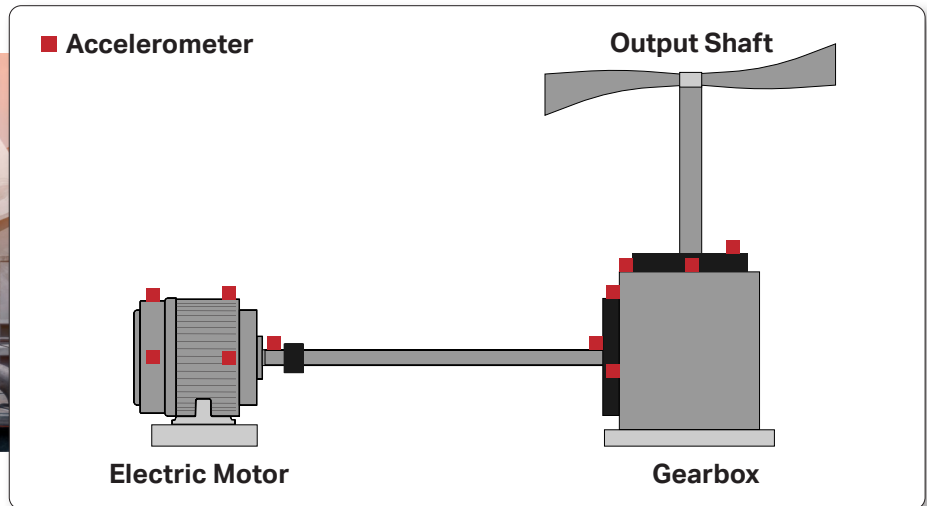



Cooling Towers Power Pack

CTC makes it easy to create an effective condition monitoring system for cooling towers using the industry's most trusted accelerometers, cables, connectors, and junction boxes.





Recommended System



- 1



AC192-1D and AC194-1D
Compact size, top and side exit accelerometers with 2 pin connectors, 100 mV/g, $\pm 10\%$
- 2

CB111-V2N-030*-L
Twisted, shielded pair cable with yellow FEP jacket and 2 socket MIL-style seal-tight Viton® boot connector with nylon insert, with L termination to connect to iBox
*30 ft (9.1 m) is average length; your actual required length may vary
- 3

JB110-12C
iBox single-axis vibration switch box, fiberglass enclosure, NEMA 4X (IP66) rated, with 12 single-output sensor inputs
- 4

Fully Customizable Data Collector Cordsets
Access data from JB110 via a BNC jack or 2 pin-MIL connector on the front of the enclosure using a cordset customized with CTC's Cable Wizard. Configure your cordset with a connector compatible with the most popular data collector brands including Acoem, Betavib, Emerson, Bently Nevada, Pruftechnik, and many more, and terminated with an 'F' (BNC plug) or K2C (2 socket MIL-style connector) to connect to your iBox.