

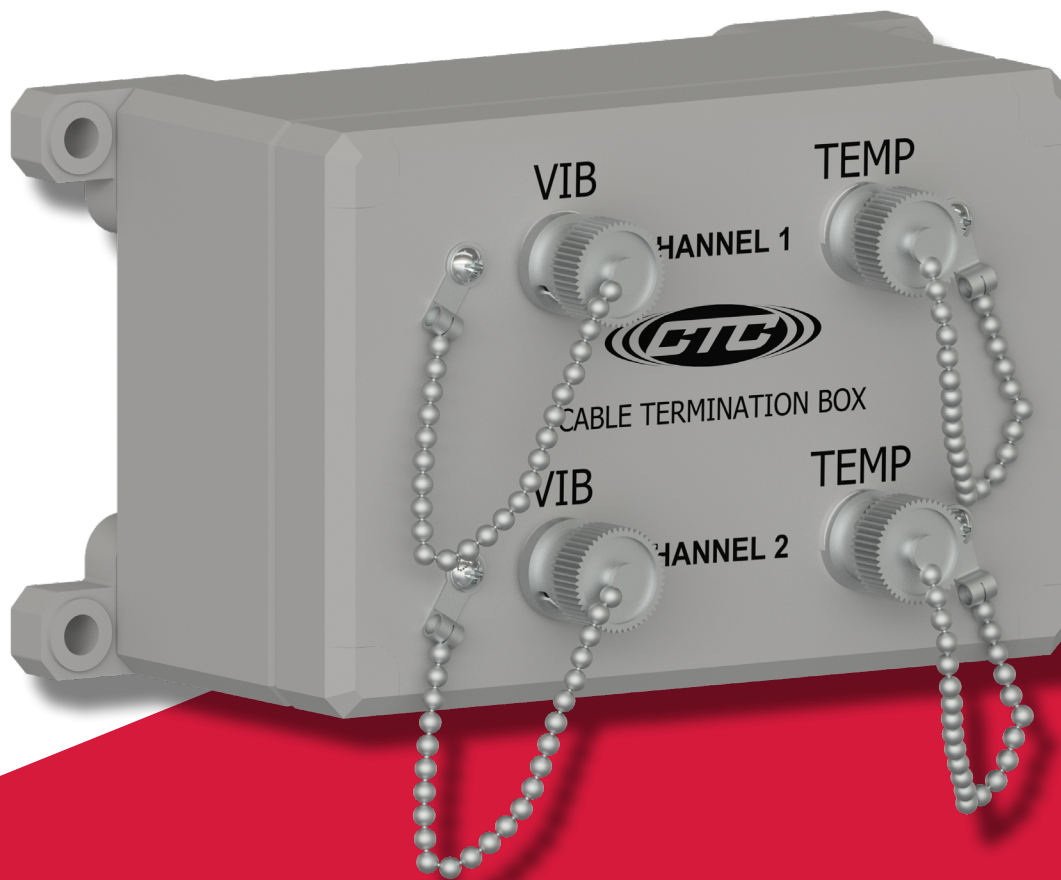

VIBRATION ANALYSIS HARDWARE



**CT142 Series Termination Box
2 Dual Output Sensor Inputs
Product Manual**

TABLE OF CONTENTS

- Introduction.....3
- Product Description.....3
- Product Dimensions.....4
- Mounting Instructions.....5
- Conduit Entry6
- Grounding.....7
- Sensor Installation9
- Post Installation Testing 12
- Maintenance 13
- Warranty and Refund Information..... 14



INTRODUCTION

CTC termination box solutions allow for the monitoring of remotely-mounted vibration sensors, which would otherwise be restricted to human access due to safety considerations.

CT142 Series Termination Box Overview: *Two dual output sensor inputs (four measurement channel outputs), polycarbonate enclosure*

The CT142 Termination Boxes are a common cable termination point for bringing compatible cables for dual output temperature and vibration sensors into a termination box for routine data collection with portable data collectors. CT series enclosures are designed to have field input cabling installed on the bottom of the cover.

Rated for IP64, the CT142 can also withstand harsh environments, including temperatures ranging from -58 °F to 180 °F (-50 °C to 82 °C). A cover featuring four self-tapping screws allows the box to be sealed from the elements.



PRODUCT DIMENSIONS

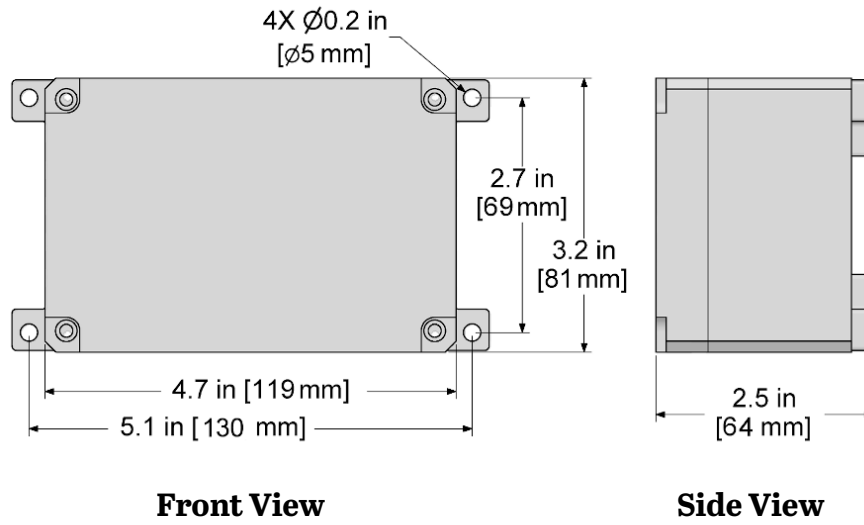

Figure 1. Dimensions

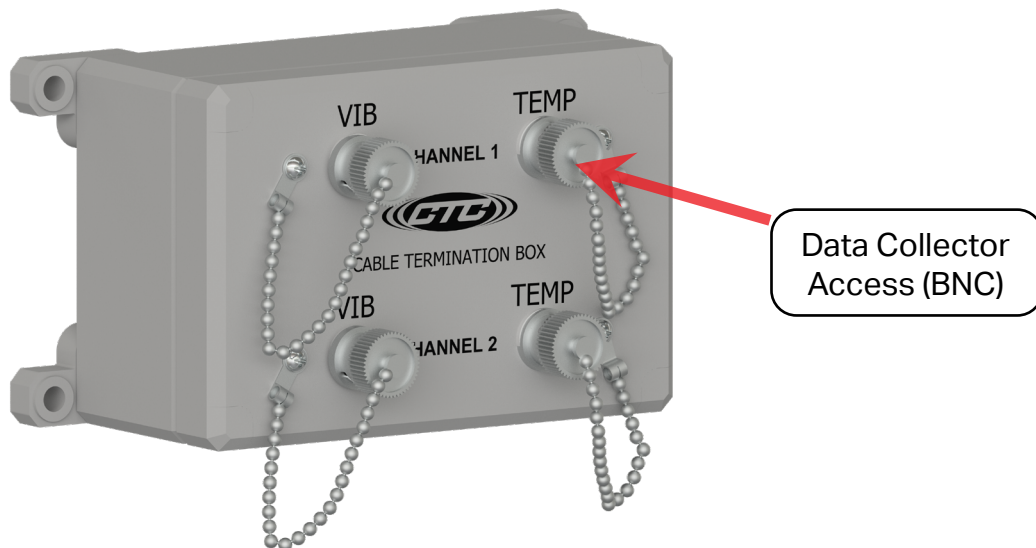

Figure 2. Diagram

MOUNTING INSTRUCTIONS

Molded mounting brackets are included on the enclosure. Wall anchoring screws are not included.

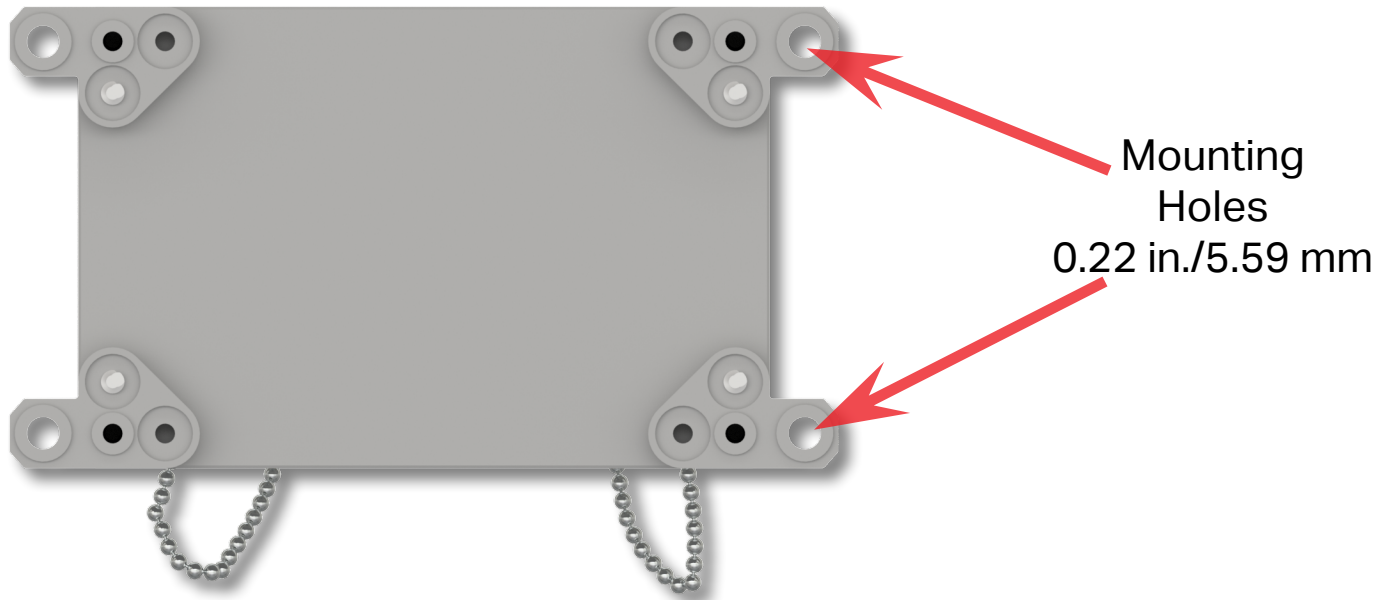

Figure 3. Cable Termination Box Rear View

CONDUIT ENTRY

If you have purchased an enclosure without cable entries provided, you should add your own entry prior to mounting the termination box. CTC does not recommend putting holes in the top of termination boxes as it will cause restricted access to the wire termination connection points and also allow possible moisture ingress.

Note: To prevent a buildup of condensation inside the enclosure, provide drainage by drilling a hole in the lowest point of the conduit.

Correct

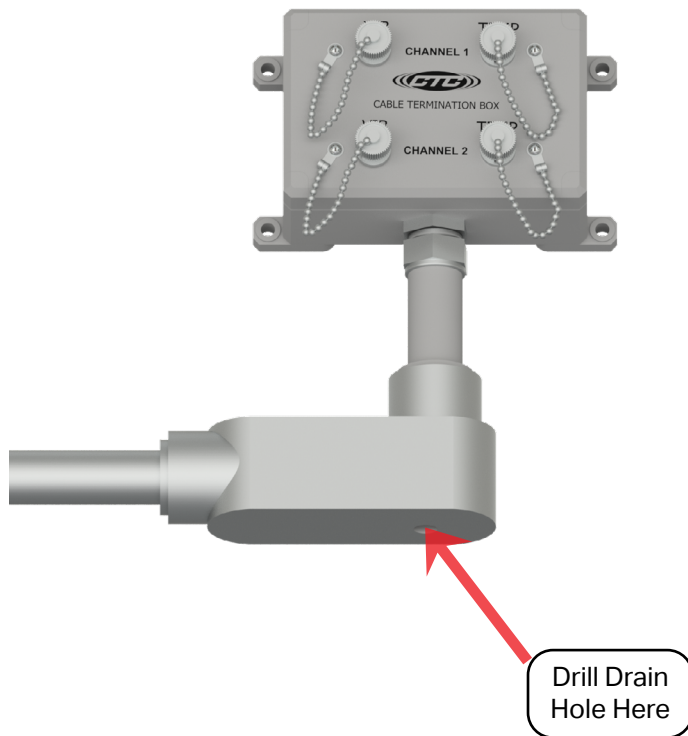

Incorrect

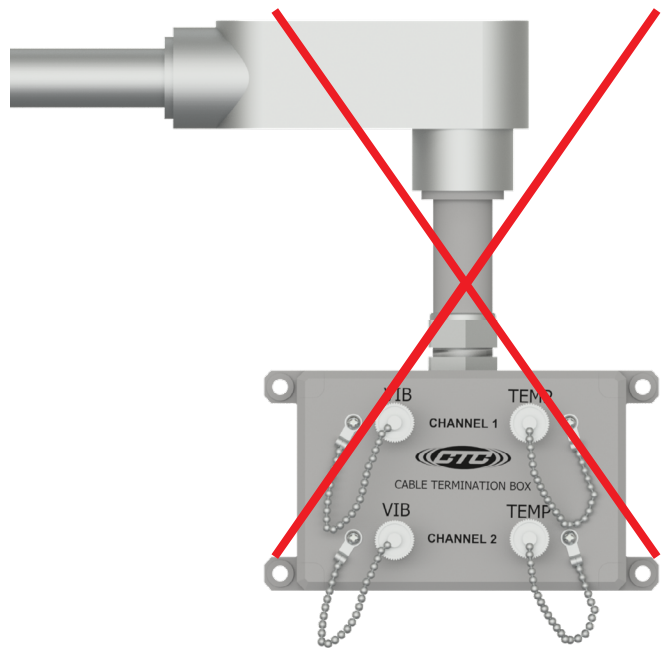

Figure 4. Conduit Entry for Termination Box

GROUNDING

Optional grounding is available on the CT142 Series. Select the “with ground lug” option (CT142G) when ordering if external grounding is desired.

A. Mounting to Earth Ground

When mounting CT142G Series termination boxes to earth ground (such as an I-Beam), mount the shield ground wire using a mounting bolt through one of the mounting brackets on the enclosure. See Figure 5 below.



Figure 5. Proper Shield Grounding Technique

GROUNDING

B. Mounting to Non-Grounded Structure

When mounting the CT142G to a non-grounded structure, ensure the shield ground wire or customer supplied ground wire is tied to a source of earth ground.

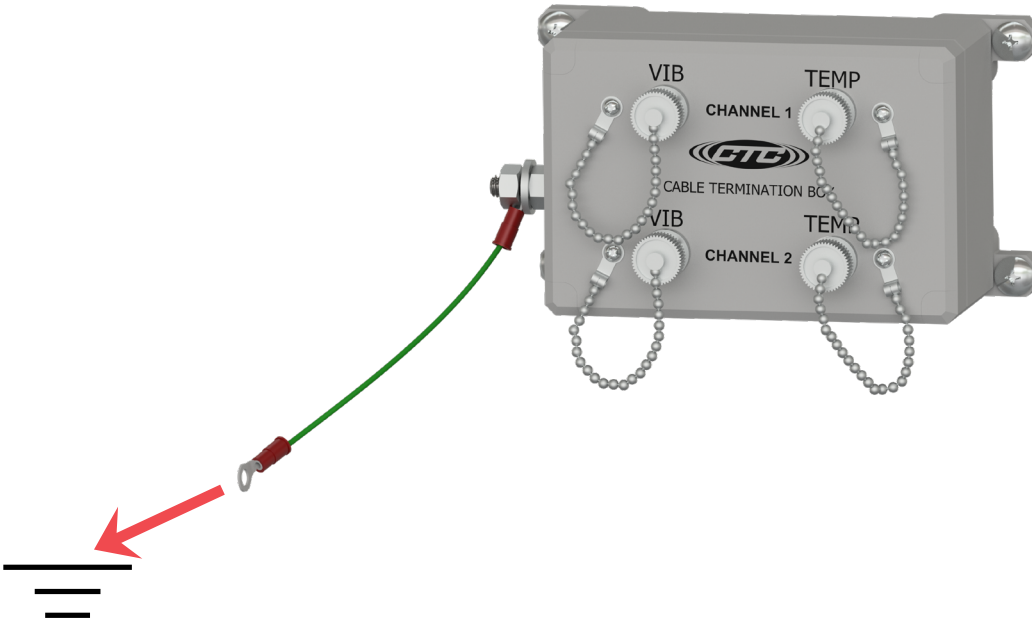

Figure 6. Ground Wire Placement

SENSOR INSTALLATION

Installation of Sensors/Signal Input Cable

1. Feed blunt-cut end through the cable entry at the bottom of the enclosure.
Note: It is recommended that cables are marked on both ends.

For cord grip cable entry, take off the cord grip cover with bushing and run cable through it then into the enclosure, hand tighten cord grip cover to base to prevent damage of cord grip.

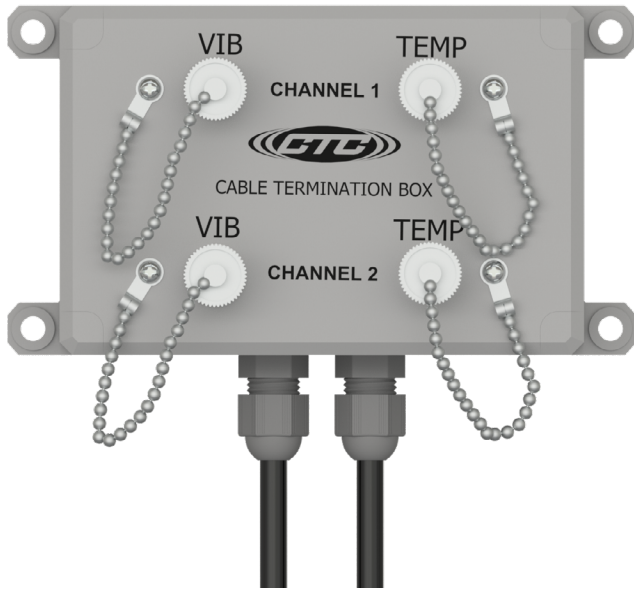

Figure 7. Front View

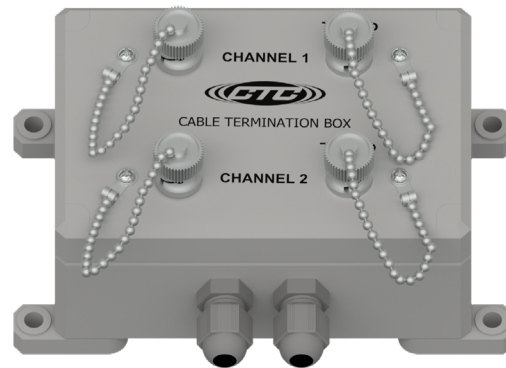

Figure 8. Bottom View with Cord Grips Installed

1. Strip outer jacket of cable back 1¼ in. and remove all of the shielding.
2. Separate the internal wires from the shield.
3. Strip red, black, and white insulation back ¼ in.



Figure 9. Stripped Wire

4. While viewing the rear of the panel, locate the appropriate channel. Using a mini flathead screwdriver, loosen the three screws for the channel and insert the wires into the termination block. Orientation is as follows:
 - a. Red insulated conductor wire is connected to (+) Vibration.
 - b. Black insulated conductor wire is connected to (-).
 - c. Shield drain wire is connected to ground (GND).
 - d. White insulated conductor wire is connected to (+) Temperature.
 - e. Tighten the screw on each wire to hold it in place.

SENSOR INSTALLATION

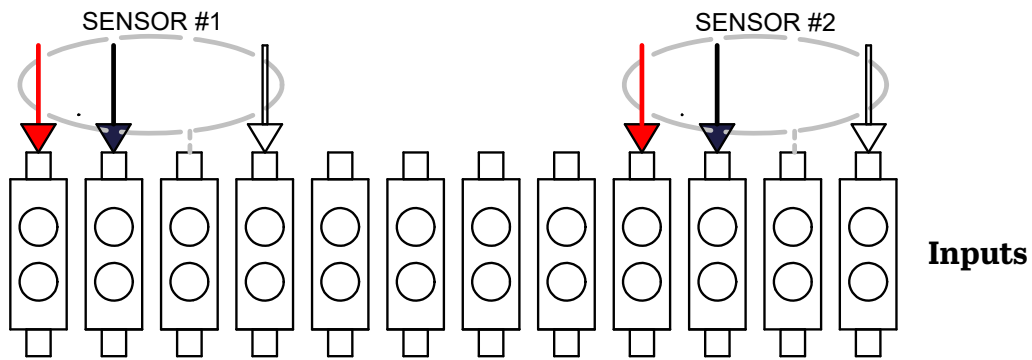

Sensor Inputs
Red = Positive Vibration
Black = Common
Grey = Shield (Ground)
White = Positive Temperature

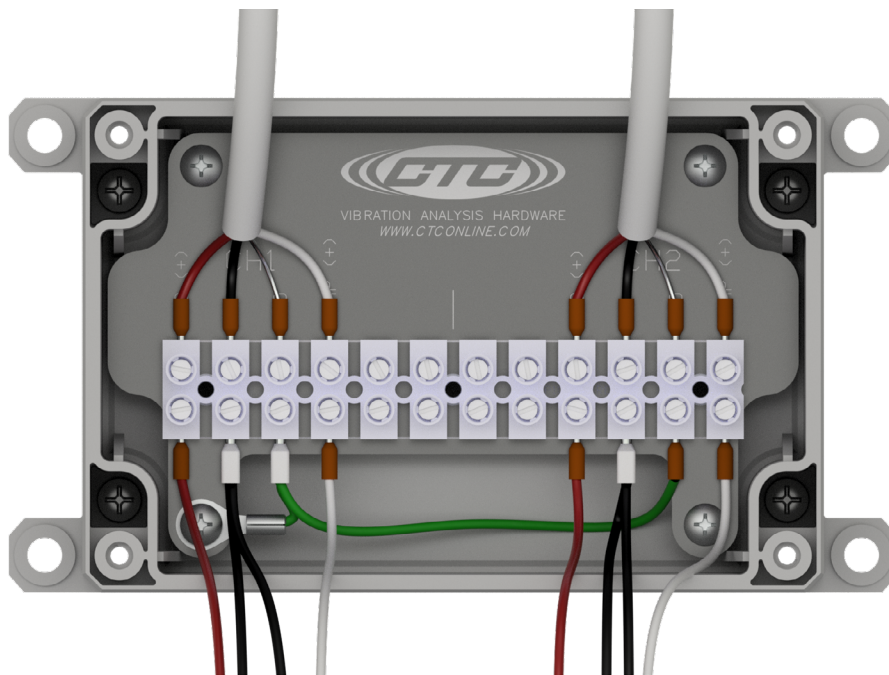

Figure 10. Field Wiring for Three-Conductor Dual Output Sensors

POST INSTALLATION TESTING

The TM1018 Accelerometer Verification Meter can be used to verify cable conductivity, sensor location and proper wiring connections. The Verification Meter will indicate if the sensor, cable and/or junction box is in working condition. It will also confirm bias voltage of the accelerometer, which will inform you of the operation of the internal accelerometer amplifier.

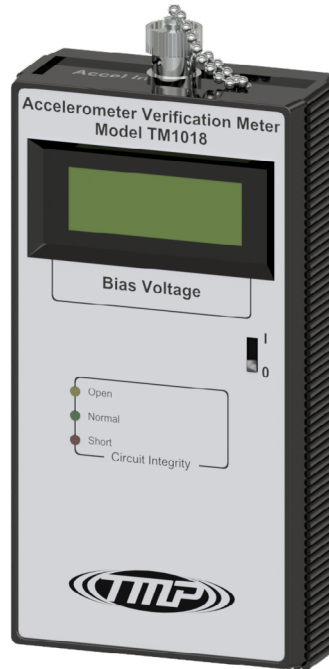

Figure 12. TM1018 Accelerometer Verification Meter

Testing Method:

1. Utilizing two personnel, Person A will be located at the termination box, while Person B will be located at the measurement location.
2. Once positioned, Person A will connect the TM1018 to the data collector output to the termination box and turn the Channel Selector to the channel that corresponds to the referenced measurement. Person A should observe a "NORMAL" LED reading.
3. Person B disconnects the cable from the accelerometer, and the TM1018 should respond with an "OPEN" LED. Reconnect the cable to the accelerometer, and the TM1018 should respond with a "NORMAL" LED.
4. Repeat for each measurement location to verify that accelerometer location is properly identified at the termination box.

POST INSTALLATION TESTING

The following LED Readout indicates the circuit integrity:

1. Green LED: Normal. Indicates proper connection and an output bias will be given, indicating the health of the sensor (4 – 16 V indicates a healthy accelerometer).
2. Yellow LED: Open Circuit. Indicates one of the following:
 - a. Cable connector is not connected to accelerometer.
 - b. Cable is open circuit (broken or not connected at one end).
 - c. Accelerometer is not functioning correctly.
3. Red LED: Short Circuit. Indicates one of the following:
 - a. Water or contamination in the connector.
 - b. Reverse wiring ((+) and (-) leads are reversed) at terminal block inputs of the termination box.
 - c. Wires in termination box or cable connector (+) & (-) are touching.

MAINTENANCE

Once the system has been installed, it requires minimal maintenance. Basic checks to ensure system integrity should be made periodically.

Visual inspection should include examinations for the following:

1. No Visible electrical burns or smoke inside the enclosure.
2. No moisture or condensation is present inside the enclosure.



WARRANTY AND REFUND

Warranty

All CTC products are backed by our unconditional lifetime warranty. If any CTC product should ever fail, we will repair or replace it at no charge.

Refund

All stock products can be returned for a 25% restocking fee if returned in new condition within 90 days of shipment. Stock products qualify for free cancellation if your order is cancelled within 24 hours of purchase. Built-to-order products qualify for a 50% refund if returned in new condition within 90 days of shipment. Custom products are quoted and built specifically to the requirements of the customer, which may include completely custom product designs or private labeled versions of standard products for OEM customers. Custom products ordered are non-cancellable, non-returnable and non-refundable.

