

CONNECTION TECHNOLOGY CENTER'S
GUIDE TO

Proximity Probes



**PROTECTION AND RELIABILITY
INSTRUMENTS**

Standard Mount
Proximity Probes

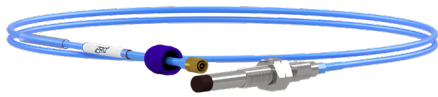

Reverse Mount
Proximity Probes

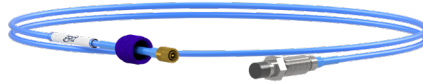

Armor Jacketed
Proximity Probes



We are proud to offer proximity probe systems that meet API Standard 670 constructed with durable stainless steel and backed by our industry leading lifetime warranty on materials and workmanship.

- Multiple case & thread lengths available
- 5 mm Focused Face View (FFv) probe tip diameter with 1/4-28 or M8x1 threaded body
- 8 mm, 11 mm and 25 mm diameter probe tips
- Probe tip and body sealed to prevent fluid/water ingress (IP68 rated)
- English and metric size case threads
- Can be tuned to different shaft materials



FFv 5 mm
Probe Tip



8 mm
Probe Tip

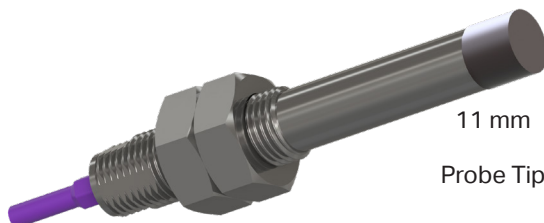

11 mm
Probe Tip

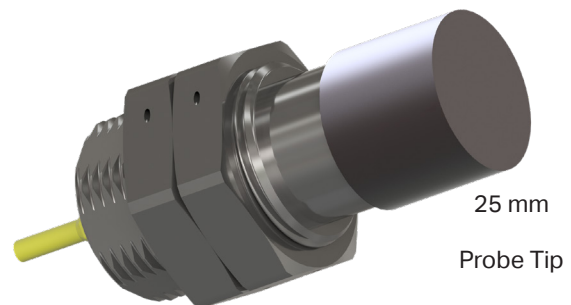

25 mm
Probe Tip

5 & 9 Meter Lengths Available
5 & 7 Meter Lengths for FFv

Probe Driver

- Flexible system configuration
- DC gap and shaft vibration signals available via buffered BNC jack for analysis
- Mounting options: Panel, DIN rail
- 4-20 mA options available
- Hazardous rated options available



Driver Enclosure

This driver enclosure allows you to protect up to six proximity probe drivers from dirt, dust, oil, and water.

Optional, factory installed DC power supply, prewired to drivers.



Extension Cables



PRO extension cables are FEP or armor jacketed and cost effective as a component of a complete vibration monitoring assembly.

Connector Protector Options:

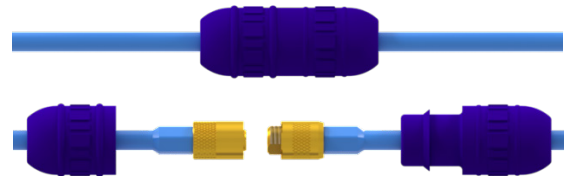

Booted Connector Protector



Self-Adhesive Silicone Tape

Mounting Hardware

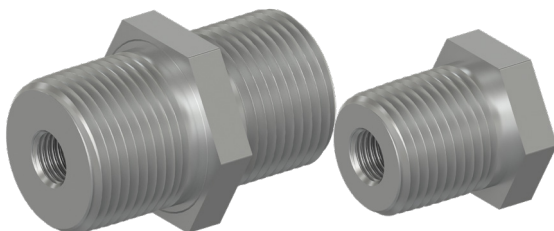

Mounting Bushings

1/2"-14 NPT, 3/4"-14 NPT, 3/4"-14 NPSM

1/4"-28, 3/8"-24, M8 x 1, M10 x 1 Threaded Holes

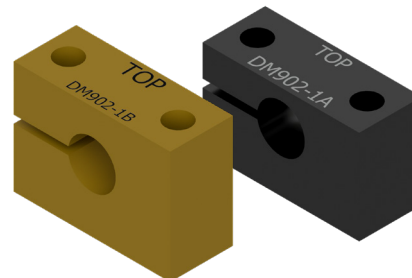

Clamping

Mounting Blocks (Standard & Metric)

Mounting Blocks are available in aluminum or phenolic materials

CTC is the world leader in the design and manufacture of industrial accelerometers, piezo velocity transducers, 4-20 mA vibration sensors, and proximity probes as well as all related mounting hardware, cabling, and junction boxes. Our products enable efficient vibration monitoring for predictive maintenance in a wide variety of industries. Industries served include cement, mining, petrochemical, food & beverage, auto, steel, wind, paper & pulp, power generation, water & wastewater treatment, pharmaceutical, hospitals, bottling, and more. Our mission is to offer the widest variety of accelerometers and vibration hardware products, which are compatible with data collectors and online monitoring systems, as well as the tools for installation.



The PRO line offers the industry's most reliable proximity probe sets.

All PRO products are backed by a lifetime warranty on materials and workmanship. PRO will repair or replace any of our products as long as the product was not subjected to misuse, neglect, natural disasters, improper installation, or modification.

All stock products may be returned for a 25% restocking fee if returned in new and unused condition within 90 days of shipment. Built-to-order and private-label products qualify for a 50% refund if returned in new and unused condition within 90 days of shipment. Custom products are quoted and built specifically to the requirements of the customer, which may include completely custom product design or private-labeled versions of standard products for OEM customers. Custom products are non-cancelable, non-returnable, and non-refundable.

