

WIRING INSTRUCTIONS

MMX1000 SERIES TERMINATION BOX

1. Strip outer jacket of cable back 1¼ in. and remove all of the shielding.
2. Separate the internal wires from the shield and twist the shield drain wire.
3. Strip red and black insulation back ¼ in.

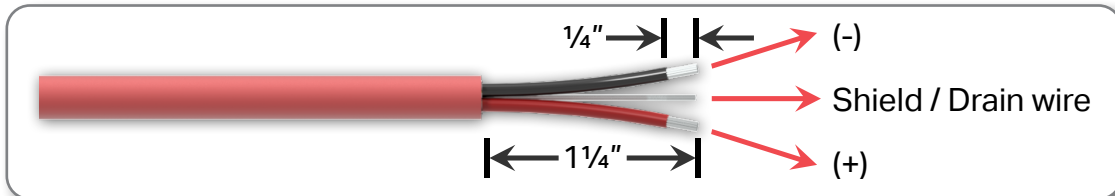

4. Locate the appropriate plug, identified by channel number, remove the plug and install the wires using a small flathead screwdriver. Push plug back into location.

Orientation is as follows:

- a. Red insulated conductor wire is connected to (+).
- b. Black insulated conductor wire is connected to (-).
- c. Shield drain wire is connected to ground (GND).
- d. Depress selected position button on input terminal block to open terminal for respective wire
(May need mini flat head screwdriver).



[Visit our website](#) to download the full manual for MMX1000 enclosures.



WIRING INSTRUCTIONS

MMX1000 SERIES TERMINATION BOX

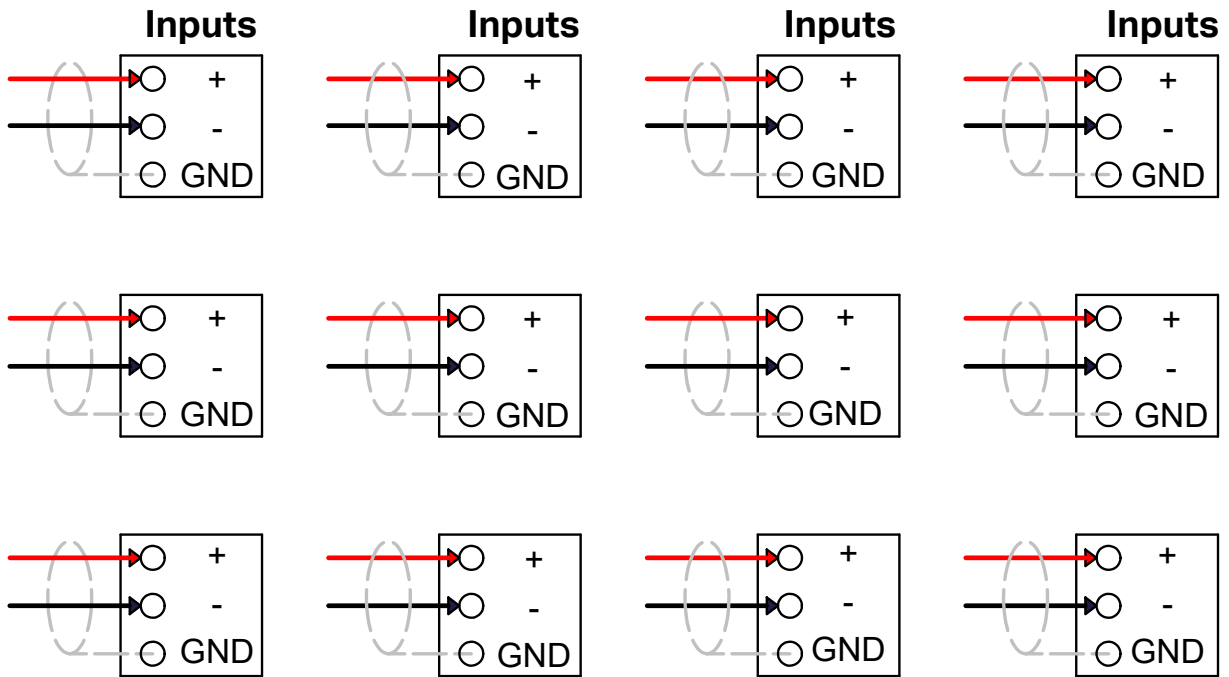

Sensor Inputs
Red = Positive Vibration
Black = Common
Grey = Shield (Ground)

