

# TRIAxIAL WIRING INSTRUCTIONS

## MX202 SERIES SWITCH BOX

1. Strip outer jacket of cable back 1¼ in. and remove all of the shielding.
2. Separate the internal wires from the shield and twist the shield drain wire.
3. Strip red, black, green, and white insulation back ¼ in.

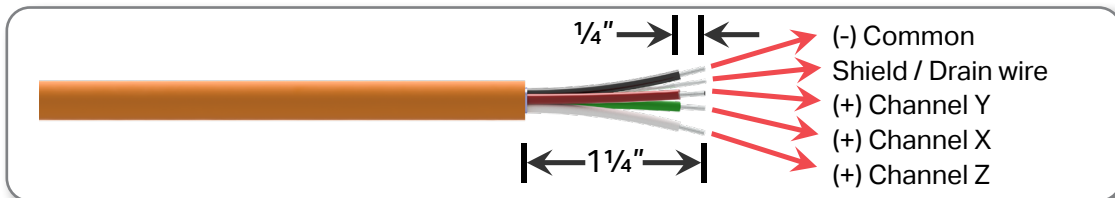

4. Locate the appropriate plug, identified by channel number, remove the plug and install the wires using a small flathead screwdriver. Push plug back into location.

### Orientation is as follows:

- a. Red (Y) insulated conductor wire is connected to the first channel
- b. Green (X) insulated conductor wire is connected to the second channel
- c. White (Z) insulated conductor wire is connected to the third channel
- d. Black (-) insulated conductor wire is connected across each (-) channel connection
- e. Shield drain wire is connected to the ground (GND) connection at one of the three channels



[Visit our website](#) to download the full manual for MX202 enclosures.

# TRIAxIAL WIRING INSTRUCTIONS

## MX202 SERIES SWITCH BOX

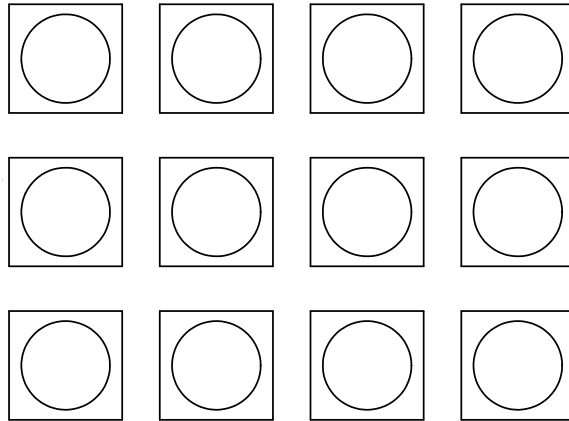

### Inputs

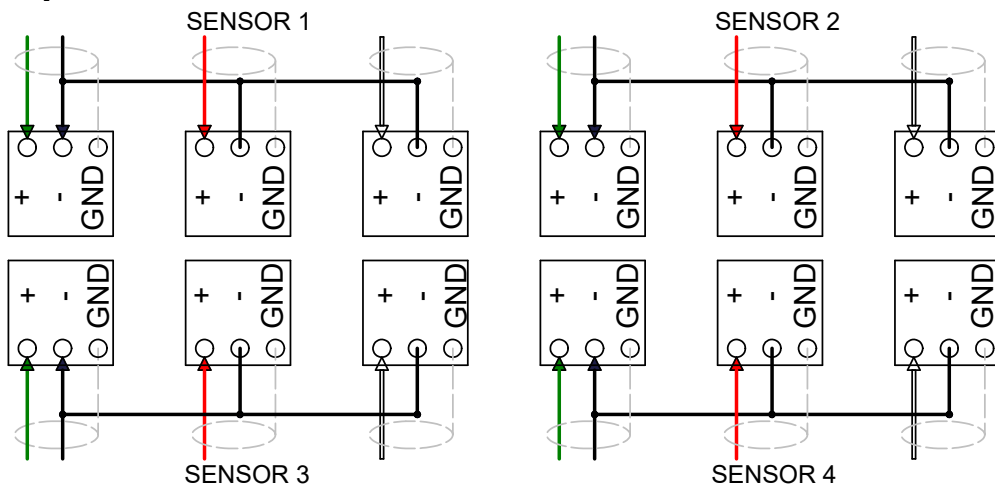

### Inputs

- Sensor Inputs
- Green = Positive X Axis
- Red = Positive Y Axis
- White = Positive Z Axis
- Black = Common
- Grey = Shield (Ground)

