

SINGLE AXIS WIRING INSTRUCTIONS

MX505 SERIES MINI MAXX BOX

1. Strip outer jacket of cable back 1¼ in. and remove all of the shielding.
2. Separate the internal wires from the shield and twist the shield drain wire.
3. Strip red and black insulation back ¼ in.

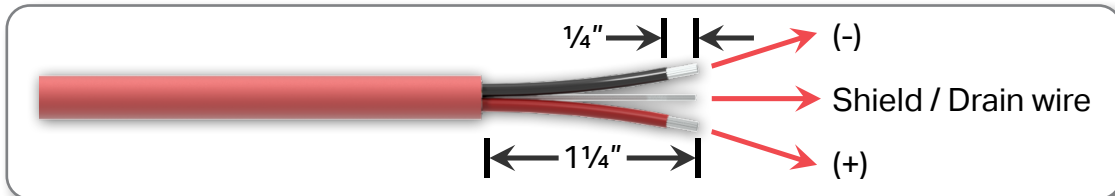

4. While viewing the rear of the panel, locate the appropriate channel. Using a mini flathead screwdriver, loosen the three screws for the channel and insert the wires into the termination block.

Orientation is as follows:

- a. Red insulated conductor wire is connected to (+) on one of the three channels.
- b. All black insulated conductor wires are connected to (-).
- c. All shield drain wires are connected to ground (GND).
- d. Tighten the screw on each wire to hold it in place.



[Visit our website](#) to download the full manual for MX505 enclosures.



SINGLE AXIS WIRING INSTRUCTIONS

MX505 SERIES MINI MAXX BOX

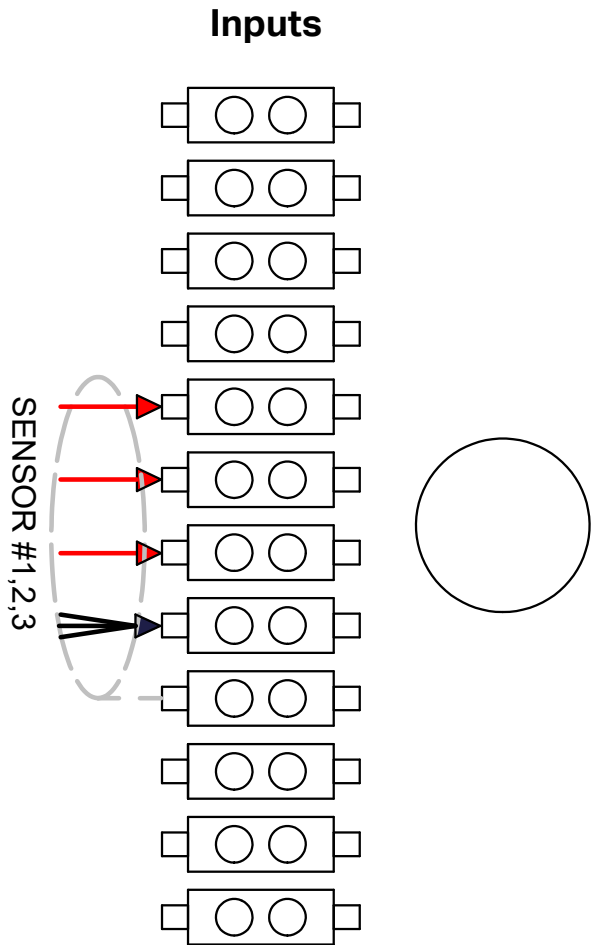

Sensor Inputs
Red = Positive
Black = Common
Grey = Shield (Ground)

