

WIRING INSTRUCTIONS

SSB1001 SERIES MODULAR SWITCH BOX

1. Strip outer jacket of cable back 1¼ in. and remove all of the shielding.
2. Separate the internal wires from the shield and twist the shield drain wire.
3. Strip red and black insulation back ¼ in.

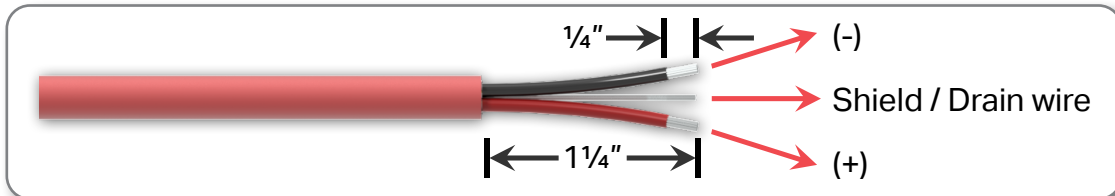

4. Locate the appropriate plug, identified by channel number, remove the plug and install the wires using a small flathead screwdriver. Push plug back into location.

Orientation is as follows:

- a. Red insulated conductor wire is connected to (+).
- b. Black insulated conductor wire is connected to (-).
- c. Shield drain wire is connected to ground (GND).
- d. Depress selected position button on input terminal block to open terminal for respective wire
(May need mini flat head screwdriver).



[Visit our website](#) to download the full manual for SSB1001 enclosures.



WIRING INSTRUCTIONS

SSB1001 SERIES MODULAR SWITCH BOX

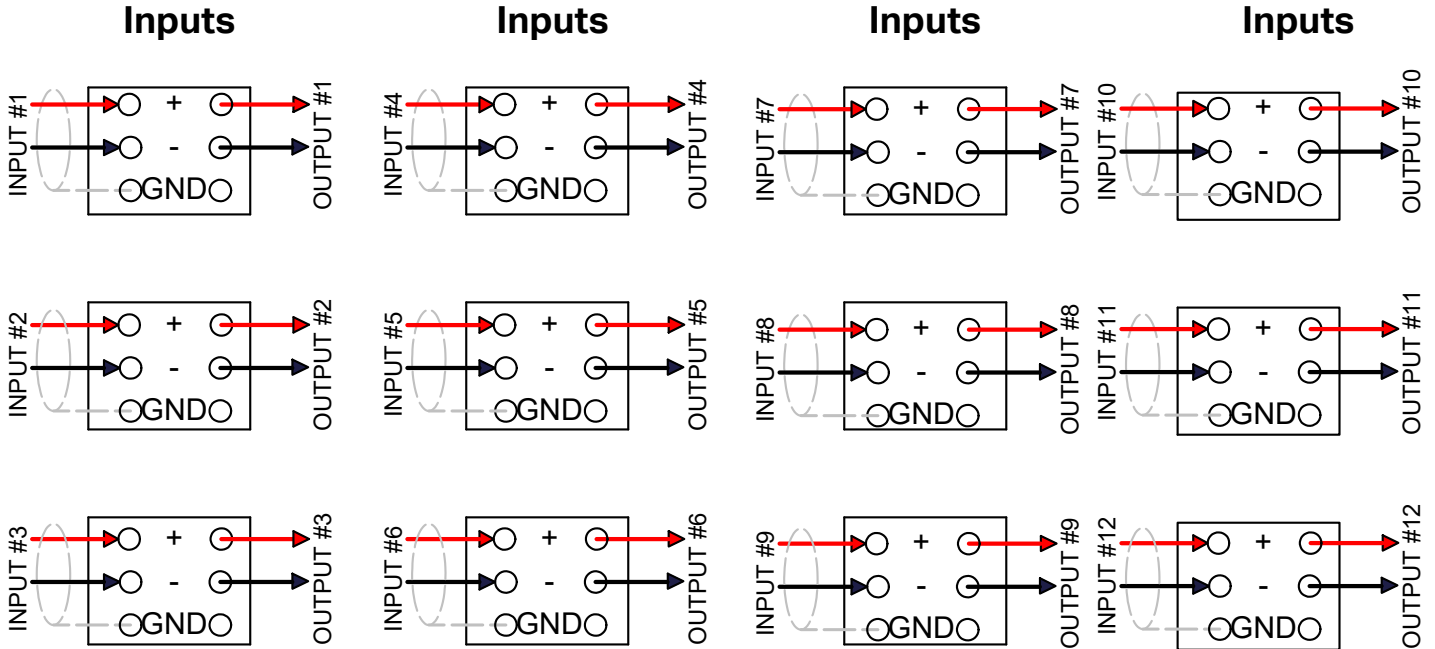

Sensor Inputs

Red = Signal/Power (+)
 Black = Common (-)
 Grey = Shield (Ground)

Sensor Outputs

Red = Signal/Power (+)
 Black = Common (-)

